

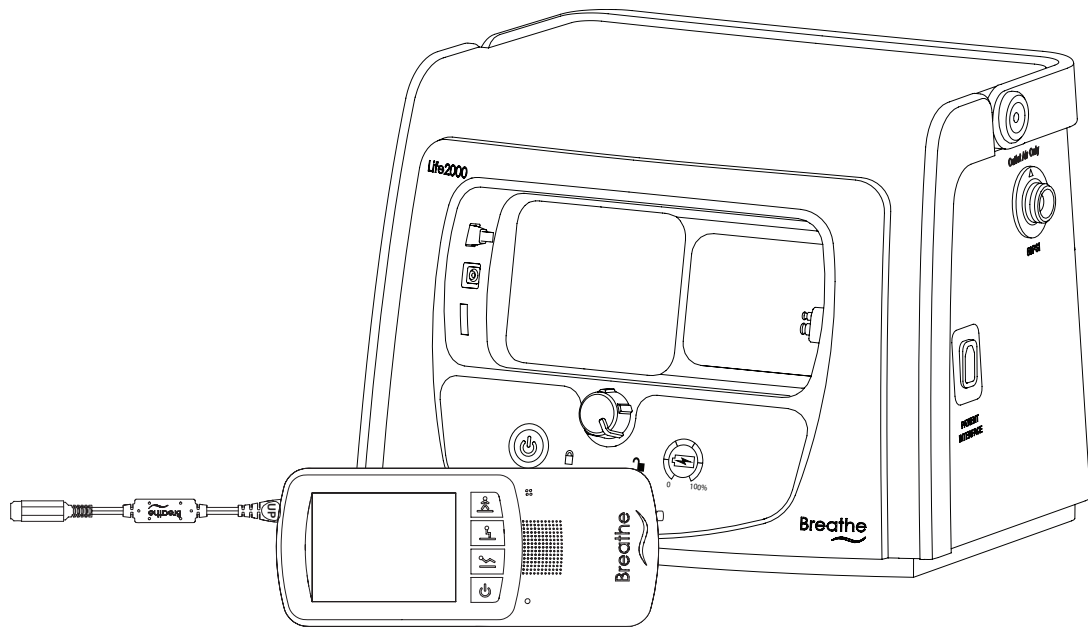

Hillrom™



LIFE2000® VENTILATION SYSTEM

Instructions for use

Rx Only

NOTICE OF EMERGENCY USE OF VENTILATORS DURING THE COVID-19 PANDEMIC

The FDA issued a guidance document on March 24, 2020, Enforcement Policy for Ventilators and Accessories and Other Respiratory Devices During the Coronavirus Disease 2019 (COVID-19) Public Health Emergency. During this emergency and while the policy is in effect, FDA does not intend to object to limited modifications to the FDA-cleared indications without prior submission of a 510(k) where the modifications do not create undue risks. Hillrom™ does not yet have FDA 510(k) clearance on the use of The Life2000® Ventilator Software version 06.08.00.00. Hillrom™ intends to adhere to FDA's recommendations to market The Life2000® Ventilator with appropriate testing and labeling while the policy is in effect but does not have specific 510(k) clearance at this time.

TABLE OF CONTENTS

Life2000® Ventilation System introduction.....	1
Indications for use	1
Symbols and conventions	1
Safety Information	2
System Warnings.....	2
Accessory Warnings.....	3
Therapy Cautions.....	4
System Cautions.....	4
Accessory Cautions.....	5
Features	6
Packaging contents.....	7
Life2000® Ventilator versions	8
Identifying the REF number.....	8
System components	9
Compressor.....	10
Configurations	11
Stationary configuration	11
Extended Range (Wearable inside home) configuration	11
Stand-Alone (Wearable outside home) configuration	11
Stationary configuration.....	12
Introduction to Stationary configuration.....	12
Stationary configuration setup checklist.....	12
Refer to the chapter contents for full instructions, warnings, and cautions.	12
Testing the ventilation system.....	12
Positioning and carrying the compressor	13
Supplying power to the compressor	14
Docking the ventilator into the compressor	15
Connecting an interface to the compressor.....	16
The outlet fitting in Stationary configuration	16
Powering on sequence in Stationary configuration	17
Checking the compressor’s internal battery status	18
Silence alarm button on the compressor	18
Powering off sequence in Stationary configuration	19
Extended Range configuration (Wearable inside home).....	20
Introduction to Extended Range configuration.....	20
Extended Range configuration setup checklist	20

Testing the ventilation system.....	20
Positioning and carrying the compressor	21
Supplying power to the compressor	22
Connecting the ventilator and compressor in Extended Range configuration.....	23
Connecting an interface to the ventilator in Extended Range configuration	24
The Combo ₂ ® hose.....	24
Connecting to a low-flow oxygen concentrator using the Combo ₂ ® hose.....	25
Powering on sequence in Extended Range configuration	26
Checking the compressor’s internal battery status	27
Assembling the ventilator battery charger and charging the ventilator	28
Securing the ventilator belt clip	29
Pole mount.....	29
Ventilator silence alarm button	30
Powering off sequence in Extended Range configuration	31
Disconnecting Extended-Range configuration.....	31
Stand-Alone configuration (Wearable outside home)	32
Introduction to Stand-Alone configuration.....	32
Stand-Alone configuration setup checklist	32
Testing the ventilator	32
Connecting to a cylinder.....	33
Connecting an Interface to the ventilator in Stand-Alone configuration	35
Powering on sequence for the ventilator.....	35
Assembling the ventilator battery charger and charging the ventilator	36
Securing the ventilator	37
Belt clip	37
Pole mount	38
Ventilator Silence Alarm Button	39
Powering Off Sequence For the Ventilator.....	39
Connecting an interface	40
The Breathe Interfaces.....	40
Connecting an interface to the ventilator in Stationary, Extended Range, or Stand-Alone configuration.....	40
The Universal Circuit® Connector.....	41
Examples of Patient Mask and Tube Connections	42
Using the Life2000® Compressor with the Universal Circuit Connector and mask.....	42
Connecting the Universal Circuit® Connector to the oxygen adapter and patient mask or tube..	43
Breathe Pillows Entrainment Interface	44
Wearing the Breathe Pillows Entrainment Interface.....	45

Checking the Breathe Pillows Entrainment Interface positioning	45
Ventilation settings.....	46
Introduction to ventilation settings.....	46
Home screen	46
Moving between the home screen and menu screen.....	47
Menu screen	47
Touch screen energy-save mode.....	47
Defining clinical settings.....	48
Accessing the settings menu	48
Accessing the clinician’s settings menu.....	48
Disabling access to the clinician’s settings menu.....	49
Automatic timeout.....	49
Powering off	49
Prescription settings	50
Editing prescription settings	50
Activating prescription settings	51
Factory default prescription settings.....	52
Breath types.....	53
Mandatory breath.....	53
Assisted breath.....	53
Ventilation modes.....	53
Ventilation settings and modes.....	53
Setting ventilation parameters in control ventilation mode	54
Setting ventilation parameters in assist/control ventilation mode	56
Setting ventilation parameters in assist ventilation mode	58
Ventilation settings summary	60
Setting alarm limits for breath rate and PIP	61
Alarm limits settings summary.....	61
Setting breath timeout (Apnea backup ventilation mode).....	62
Breath timeout settings summary	62
Selecting the source gas	63
Source gas settings summary	63
Choosing an activity button (Patient selectable) to begin ventilation.....	64
“Incompatible Settings” message	65
“This Prescription Setting is not active” message	65
“Connect Oxygen source” or “Disconnect Oxygen source” message	65
Adjusting the trigger sensitivity (Patient adjustable)	66
Accessing the trigger sensitivity screen.....	66

Changing trigger sensitivity	67
Accessing the utilities menu	68
Setting time and date	69
Setting vibration mode	70
Vibration settings summary	70
Setting audio loudness	71
Loudness settings summary	71
Adjusting screen brightness	72
Brightness settings summary	72
Viewing software version information.....	73
Summary of factory default settings.....	74
Alarms, alerts, and troubleshooting	75
Introduction to alarms and alerts.....	75
Ventilator alarms.....	75
Compressor alerts.....	75
Ventilator on-screen alarm sounds and message display.....	76
Active Alarms Window	76
Silencing and Clearing On-Screen Alarms	77
Ventilator alarms	78
High-priority alarms	78
Medium-priority alarms.....	86
Low-priority alarms.....	94
Compressor alerts	97
Troubleshooting	99
Maintenance	110
Cleaning before first use	110
Daily checks	110
Environmental specifications.....	110
Alarm checks	110
Cleaning and disinfecting the ventilation system	111
Cleaning for single patient use	112
Ventilation system.....	112
Oxygen hoses	112
Breathe Pillows Entrainment Interface and Universal Circuit® Connector.....	112
Third-party patient mask or tube.....	112
Cleaning for multi-patient use	113
Ventilation system.....	113
Oxygen hoses	113

Breathe Pillows Entrainment Interface	113
Universal Circuit® Connector	113
Purge tube connector	113
Cleaning the breathe interfaces	114
Before cleaning	114
Clean the interface	114
Purge the interface	114
Dry the interface	114
Purge the interface again.....	114
Purging the Universal Circuit® Connector	115
Purging the Breathe Pillows Entrainment Interface.....	116
Preventive maintenance	118
Battery replacement	118
Checking and replacing the condensation tray	119
Checking and replacing the air inlet filter	120
Checking and replacing the cooling filter assembly	121
Testing ventilator alarms	122
Verifying power-on self-test alarms.....	122
Verifying backup alarm buzzer	122
Testing alarm conditions	123
Equipment required for testing.....	123
Testing setup.....	124
Testing the Low Gas Pressure alarm (Medium priority)	125
Testing the High Delivery Pressure alarm (Medium priority).....	125
Testing the Low PIP alarm (Medium priority) and Low Delivery Pressure alarm (Medium priority)	126
Testing the High PIP alarm (High priority).....	127
Testing the Breath Timeout alarm (Medium priority) and High Circuit Pressure alarm (High priority).....	128
Testing the High Breath Rate alarm (Medium Priority).....	129
Testing the Low Breath Rate alarm (Medium priority)	130
Testing the Battery Low alarm (Medium-priority) and Very Low Battery alarm (High-priority).	131
After checking alarm conditions	131
Battery information	132
Checking the Ventilator Battery Charge.....	132
Ventilator Battery Charge icons, meanings, and approximate time remaining.....	132
Ventilator battery specifications	133
Compressor battery charge status	133

When the compressor is powered by internal battery.....	133
When the compressor is connected to AC power	134
Compressor battery specifications	134
Ventilator battery charger and power cord specifications	135
Ventilator battery charger specifications	135
Ventilator power cord specifications	135
Compressor power supply and power cord specifications.....	135
Compressor power supply specifications	135
Compressor power cord specifications	135
Specifications	136
Oxygen monitor	136
Exhalation volume monitor.....	136
Ventilator altitude volume adjustment table.....	137
Performance specifications.....	138
Principles of operation.....	144
General overview.....	144
Stationary configuration operation summary and pneumatic diagram	144
Stationary configuration	144
Extended Range configuration operation summary and pneumatic diagram.....	144
Extended Range configuration.....	145
Stand-Alone configuration operation summary and pneumatic diagram.....	145
Stand-Alone configuration.....	145
Compliance IEC classification	146
Icons.....	150
Appendix	154
Accessories and Replacement Parts.....	154
Cylinder Duration Information	155
Cylinder size B: 164 liters (M6).....	155
Cylinder size D: 425 liters (M15)	155
Cylinder size E: 660 liters (M24).....	155
Oxygen usage (LPM) Table.....	156
Cylinder Duration Equation	156
Replacing the Source Gas Cylinder.....	157
Potential Tidal Volumes	158
FiO2 Tables	159
Universal Circuit® Connector using air as the pressure source*	159
Universal Circuit® Connector using oxygen as the pressure source*	159

Breathe Pillows Entrainment Interface using air as the pressure source*	160
Breathe Pillows Entrainment Interface using oxygen as the pressure source*	160
Limited Warranty	161
Warranty service.....	161
Limitations of warranty; Exclusive remedy	161

Life2000® Ventilation System introduction

Indications for use

The Life2000® Ventilation System is intended to provide continuous or intermittent ventilatory support for the care of individuals who require mechanical ventilation.

The Life2000® Ventilation System consists of the Life2000® Ventilator and the Life2000® Compressor.

The system is intended for use by qualified, trained personnel under the direction of a physician. Specifically, the system is applicable for adult patients who require the following types of ventilatory support:

- Positive Pressure Ventilation, delivered invasively (via ET tube) or non-invasively (via mask).
- Assist/Control mode of ventilation.

The system is suitable for use in home and institutional settings and is not intended for ambulance or air transportation.



WARNING

Use the Life2000® Ventilation System only for patients who meet the Indications for Use. If the ventilation system is used for patients who do not meet the Indications for Use, patients may not receive appropriate respiratory therapy.



CAUTION

Federal law restricts this device to sale by or on the order of a physician.

Symbols and conventions

The following symbols and conventions are used throughout this manual:

THIS	MEANS THIS
WARNING	Indicates hazards that, if not avoided, may cause severe injury or death.
CAUTION	Indicates hazards that, if not avoided, may result in minor or moderate injury, or damage to or impaired performance of equipment.
TIP: and TIPS:	Indicates tips that may be helpful when using the ventilation system.
NOTE: and NOTES:	Indicates additional information about a behavior or feature.
BOLD TEXT	The names of menu items and icons displayed on the touch screen are indicated with bold text. For example, the Menu screen has several icons, including Home Screen , Settings , and Information .

Safety Information

Please read the following warnings and cautions in their entirety before using the Life2000® Ventilation System. Warnings and cautions can also be found throughout this Instructions for use.



WARNINGS

Therapy Warnings

- The Life2000® Ventilation System is a restricted medical device intended for use by qualified, trained personnel under the direction of a physician.
- Use the Life2000® Ventilation System only for patients who meet the Indications for Use. If the ventilation system is used for patients who do not meet the Indications for Use, patients may not receive appropriate respiratory therapy.
- The operator of the ventilation system is responsible for reading and understanding this manual before use.
- Failure to read this Instructions for use may result in product misuse, which may cause equipment damage or patient mistreatment.
- The prescription and ventilation settings should only be changed on the order of the supervising physician.
- When switching from the Life2000® Ventilation System to a standard nasal cannula and oxygen concentrator, confirm that the oxygen flow is set at the prescribed flow rate. Ensure the setting on the oxygen concentrator remains at the prescribed oxygen liter flow while connected to the Life2000® Ventilation System. Failure to ensure the proper setting may result in inadequate therapy or patient harm.
- Appropriate patient monitoring such as checking oxygen levels with a pulse oximeter should be used as medically indicated when administering supplemental oxygen. The delivered oxygen concentration may vary, depending on the oxygen concentrator specifications, patient volume, and accessories used.
- Hillrom does not manufacture or provide service for low-flow oxygen concentrators. When using a low-flow oxygen with the Life2000® Ventilation System, follow the oxygen concentrator manufacturer's user manual for instructions, warnings, and cautions, and/or contact your oxygen provider and care team for instructions for safe use.
- Do not eat, drink, or chew gum while using the ventilation system. Food or liquids that make contact with the ventilation system may cause components in the system to malfunction. Eating, drinking, or chewing gum while using the system may also increase the risk of choking.
- To ensure accuracy of oxygen administration and to monitor for the presence of contamination (incorrect gas connected), use an external oxygen monitor to verify the oxygen concentration in the delivered gas.
- To monitor minute volume, use an external exhaled volume monitor.
- Before beginning ventilation therapy in Stand-Alone Configuration, verify that there is an adequate supply of source gas supply for the intended duration of the therapy. Otherwise, the patient may not receive appropriate therapy.
- If upgrading software from version 05.11.00 to 05.12.00 re-evaluate the ventilator settings if PEEP is applied.
- If upgrading a patient ventilator from ventilator REF MS-01-0100 to ventilator REF MS-01-0118 re-evaluate ventilator settings if PEEP is applied.

System Warnings

- When using an oxygen concentrator with the Life2000 Ventilation System, do not modify, extend or combine multiple oxygen concentrators together. Combining oxygen concentrators to achieve higher

oxygen flows may result in inadequate oxygen delivery which may cause patient injury.

- When using the Life2000® Ventilation System in the Extended Range configuration with an oxygen concentrator, do not modify or extend the tubing. Extending the tubing may result in equipment damage, and patients may not receive adequate respiratory therapy.
- If the Life2000® Ventilation System is not functioning properly, respiratory therapy may be compromised and may result in patient harm or death. Always have an alternate means of ventilation or oxygen therapy available.
- When the ventilation system is in use, keep it in a well-ventilated area to prevent it from overheating. The ventilation system may overheat and be permanently damaged if it is used in an area that is not well ventilated.
- Do not submerge the ventilation system in liquids or pour liquids on it. Liquids may cause components in the system to malfunction.
- Do not allow smoking near oxygen sources or near the ventilation system and do not place oxygen sources or the ventilation system near any source of direct heat or open flame because flammable materials burn more readily in the presence of oxygen.
- Do not use the ventilation system with oxygen in the presence of flammable anesthetics such as fluroxene, cyclopropane, divinyl ether, ethyl chloride, ethyl ether, and ethylene, as they may form flammable or explosive mixtures with oxygen.
- Do not use the Life2000® Ventilation System in magnetic resonance imaging (MRI) environments. MRI equipment may cause electronic components in the system to malfunction. Use of the ventilation system in an MRI environment may damage the ventilation system or other equipment and may cause severe injury.
- Do not use the ventilator or compressor in the presence of flammable anesthetics.
- Do not use the ventilator with helium or helium mixtures.
- Do not use the ventilator with nitric oxide.
- Do not use the ventilator in a hyperbaric chamber.
- Do not power on or use the compressor without the filters and condensation tray properly installed.
- Do not insert foreign objects into any part of the ventilation system.
- The back of the ventilator enclosure may reach 49°C in a 40°C environment.
- Do not cover or block the compressor's internal alarm buzzer with any object. Covering the buzzer may make it difficult for a patient or caregiver to hear alarms, which may result in inadequate respiratory therapy.
- Do not cover the ventilator, touch screen, speaker, or backup alarm buzzer with tape or any other object. Covering the ventilator or any of its parts might cause difficulty in hearing alarms and might affect ventilator performance.
- Only use the ventilator with the compressor or approved medical grade compressed oxygen. Use with non-approved sources of gas may cause the ventilator to malfunction and the patient may not receive appropriate respiratory therapy.
- If using the ventilator with an alternate gas source in Stand-Alone Configuration, and the ventilator is not used with a regulator capable of 41 PSI to 87 PSI (nominal 50 PSI) with greater than 40 LPM capability, patients may not receive appropriate respiratory therapy.
- Ensure that the alarm loudness is set above the loudness of your surroundings.
- Unauthorized modifications can result in equipment damage, or patient injury or death.

Accessory Warnings

- For any accessories, read the label and accompanying document(s) before use.
- Use only approved components, accessories, and replacement parts with the ventilation system described

in the Quick reference or in this Instructions for use. If unauthorized components, accessories, or replacement parts are used with the system, the ventilation system may be damaged, and performance may be degraded.

- Adding humidification or nebulization can increase the resistance of the breathing circuit. The operator of the ventilation system needs to monitor the breathing system for increased resistance and blockage.
- Ventilator accuracy can be affected by the gas added by use of a nebulizer.
- Use only a Life2000® source gas supply hose with the ventilation system. If an unauthorized source gas supply hose is used with the ventilation system, the system may be damaged.
- To prevent risk of cross-contamination, clean and disinfect the ventilation system before using it on a new patient, and use a new Breathe Pillows Entrainment Interface or Universal Circuit® Connector. For the third-party patient mask, refer to the user guide provided by the manufacturer. Replace the oxygen hose between patients.
- Breathe interfaces are designed for single-patient use. To prevent risk of cross-contamination use a new Breathe Pillows Entrainment Interface or Universal Circuit® Connector for each new patient. For third-party masks or tubes, refer to the user guide provided by the manufacturer for replacement and/or cleaning and disinfection instructions.
- The interface, source gas supply hose, and power cords should be positioned to avoid restricting movement, causing a tripping hazard, or posing a strangulation risk.
- Do not subject Breathe interfaces or source gas supply hoses to heat sterilization, hot water pasteurization, autoclaving, radiation sterilization, ethylene oxide gas sterilization, or attempt to clean them in a dishwasher or microwave oven. Doing any of these may damage the interfaces or hoses and impair gas delivery.
- If using the Breathe Pillows Entrainment Interface, properly secure the patient interface to the face and route tubing around the ears to avoid strangulation.

CAUTIONS

Therapy Cautions

- Using the outlet fitting while the ventilation system is delivering therapy in Stationary Configuration might decrease flow to the patient.
- The Life2000® Ventilation System provides high flows up to 40 LPM which may cause drying of the airway passages. Alert the physician if the patient experiences air passageway drying.

System Cautions

- No user serviceable components are inside the device; do not attempt to repair any components inside the device.
- Do not place the battery charger on wet surfaces or use in wet environments. Wet environments may damage the battery charger and may cause electric shock.
- The compressor's power supply must be certified to IEC 60601-1, IEC 60601-1-11, and be Class II and IP22.
- If using in Extended Range or Stand-Alone Configuration (wearable configurations), make sure the clip is securely fastened to the belt and the ventilator. If the clip is not securely fastened to the belt or the ventilator, the ventilator may fall and be damaged.
- If using in Extended Range or Stand-Alone Configuration (wearable configurations), secure the ventilator to prevent it from falling or becoming damaged.
- Keep in a clean environment to protect the equipment from ingress of dust, lint, and pests.
- Do not leave the ventilation system exposed to the sun or other sources of radiant heat; it may overheat.
- Do not allow children or pets to access the ventilation system; it may become damaged.

- The performance of the Life2000® Compressor has only been validated with the Life2000® Ventilator.
- Do not connect another device to the outlet fitting on the compressor when the ventilation system is in Stationary Configuration.
- Do not connect the purge tube connector to the outlet fitting on the compressor while the ventilation system is in Stationary Configuration and in use.
- The ventilator settings might not be achieved when sourced by the Life2000® Compressor when used at altitudes near or above 2500 feet, in high temperature, or in high humidity. If the ventilator settings cannot be achieved, the patient may not receive adequate respiratory therapy and you should switch to an alternate means of ventilation.
- Follow local regulations and NFPA 55 in the handling and use of oxygen cylinders.

Accessory Cautions

- Use only the approved battery charger and cord set with the ventilation system. If an unauthorized battery charger or cord set is used with the ventilation system the system may be damaged.
- A recommended 90-day replacement schedule for the Universal Circuit® Connector and the Breathe Pillows Entrainment Interface.
- Do not use a Breathe Pillows Entrainment Interface or Universal Circuit® Connector that is cracked, odorous, broken, or kinked. If a damaged interface is used, the patient may not receive adequate respiratory therapy.
- 70% isopropyl alcohol may damage the touch screen. When cleaning external surfaces of the ventilation system with 70% isopropyl alcohol, avoid contact with the touch screen.

Features

The Life2000® Ventilation System is a critical care, volume control mechanical ventilation system designed for a broad range of applications in critical care and home settings.

The modular Life2000® Ventilation System (system) is composed of the Life2000® Ventilator (ventilator) and the Life2000® Compressor (compressor).

The ventilator:

- Offers three different volume control modes of operation:
 - Control Ventilation
 - Assist/Control Ventilation
 - Assist Ventilation
- Can be used with a variety of commercially available invasive interfaces (such as ET tubes) or non-invasive masks such as full face, nasal, and pillows masks.
- Enables clinicians to define three prescriptions based on patient need.
- Allows for an adjustable PEEP setting for each prescription.
- Allows for an adjustable trigger sensitivity for each prescription.
- Includes the ability to set various critical alarms for each prescription.
- Has up to four hours of battery-powered operation.
- Displays patient breath rate, Peak Inspiratory Pressure (PIP), average flow, and current volume level.

The compressor:

- Provides a continuous 50-PSI pressure source.
- Is a charging station for the ventilator.
- Has an internal battery with one hour of operation.

Packaging contents

WARNING

For any accessories, read the label and accompanying document(s) before use.

TIP

The ventilation system is shipped in specially designed, protective boxes. Do not throw away the boxes; keep them for future transportation needs.

1 Life2000® Ventilator (ventilator)

The ventilator can be used with the Life2000® Compressor or an alternate 50-PSI pressure source.

NOTE:

Ventilators may not be configured with the Battery Charger Dongle.

2 Life2000® Compressor (compressor)

The compressor is an electropneumatic power unit that provides the ventilator with a continuous pressure source and is a charging station for the ventilator.

3 Belt clip for ventilator

The belt clip is used to secure the ventilator when it is used in wearable configurations.

4 Battery charger and AC power cord for the ventilator

The battery charger and AC power cord connect the ventilator to an AC power source.

5 External power supply and AC power cord for the compressor.

The external power supply and AC power cord connect the compressor to an AC power source.

6 Ventilator carry pouch

Alternative to belt clip for securing the ventilator when using in wearable configurations.

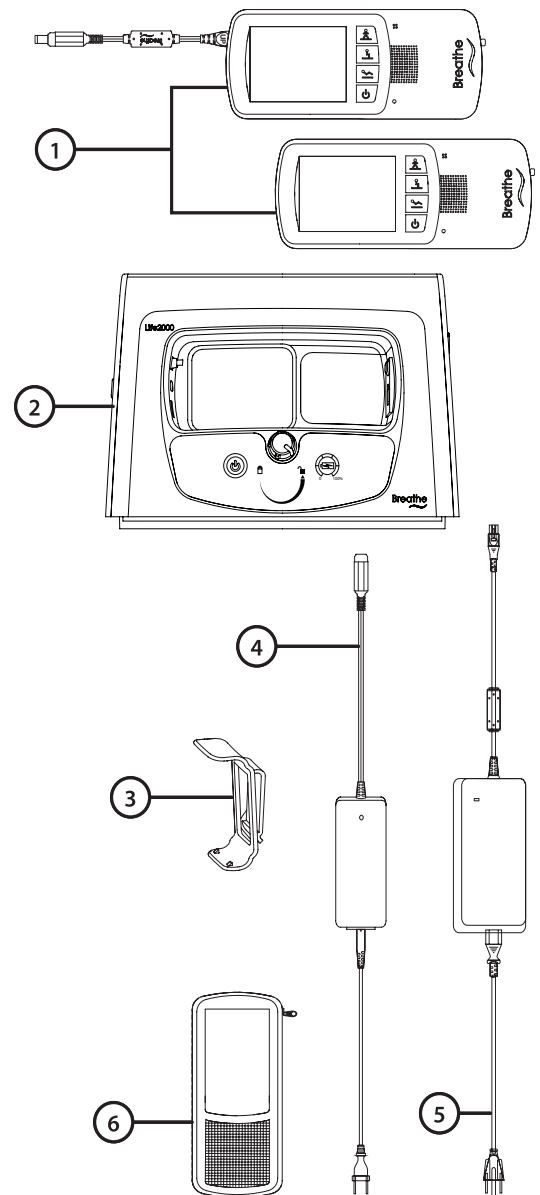

Life2000® Ventilator versions

There are two released ventilator versions of the Life2000® Ventilator. You will be able to identify the version of the ventilator based on the REF number.

The functionality of the ventilator's Communication Port, Battery Charge Icon, and System Alarms differ for each version of the ventilator. Please make sure to identify the REF number of the ventilator to ensure proper use of your system.

Identifying the REF number

The REF number is located on the label on the back of the ventilator, see examples below.

Ventilator REF MS-01-0100, released prior to Sept 16, 2019



Ventilator REF MS-01-0118, released after Sept 19, 2019

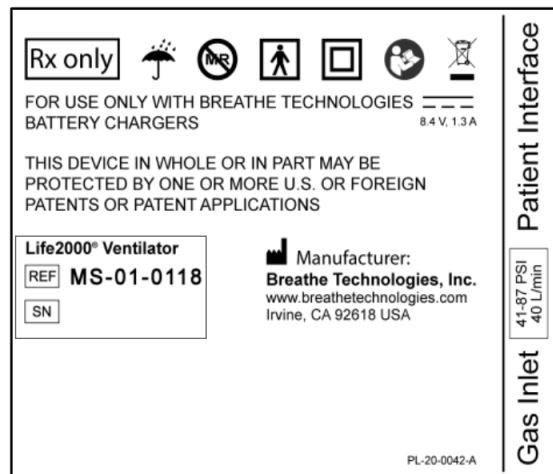

System components

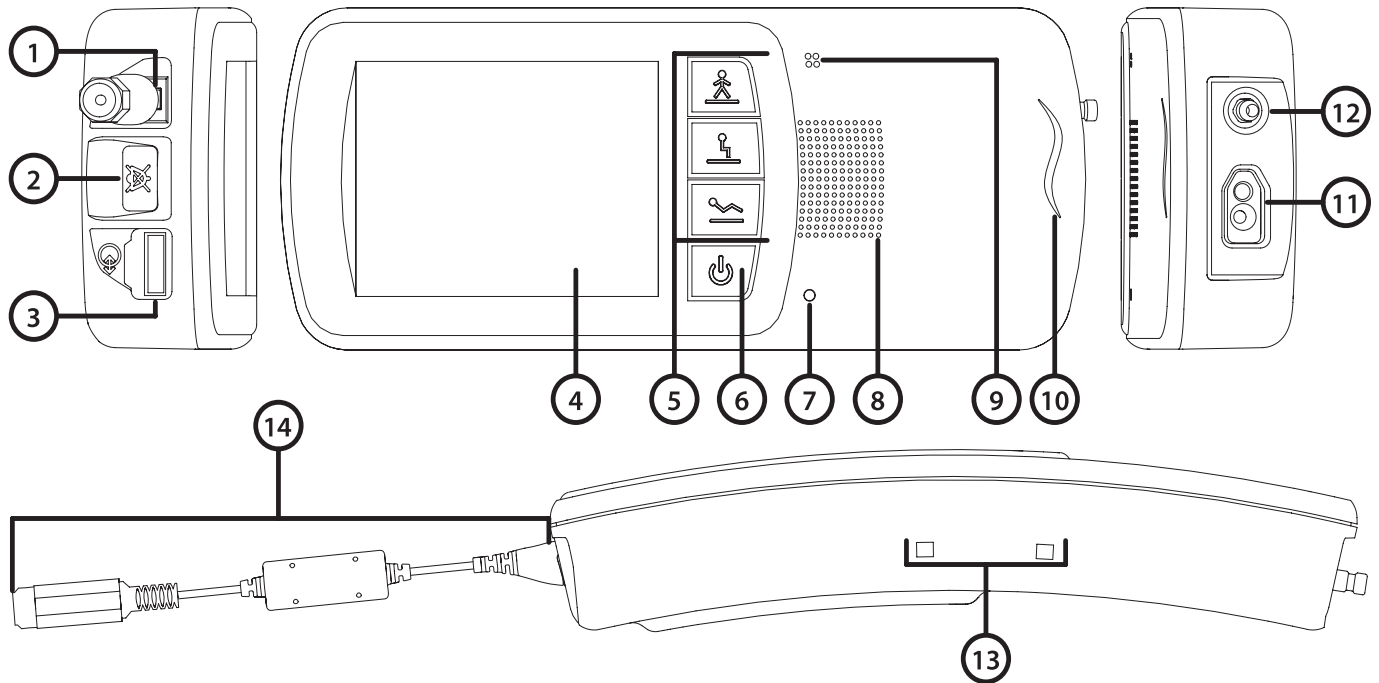



Ventilator

TOP

- ① Battery charger connection
- ② Silence Alarm button
- ③ Ventilator REF MS-01-0100
For manufacturer's use only
Ventilator REF MS-01-0118
Communication port

FRONT

- ④ Touch screen
- ⑤ Activity buttons
 -  High Activity button
 -  Medium Activity button
 -  Low Activity button
- ⑥ Power button for ventilator
- ⑦ Power indicator light
- ⑧ Alarm speaker
- ⑨ Backup alarm buzzer
- ⑩ Breath indicator light

BOTTOM

- ⑪ Interface connection
 - ⑫ Gas inlet connection
- #### SIDE
- ⑬ Belt clip sockets
 - ⑭ Battery Charger Dongle*

*Ventilators may not be configured with the Battery Charger Dongle.

Compressor

FRONT

- ① Ventilator docking cradle
- ② Power source indicator light
- ③ Power button for compressor
- ④ Locked icon
(ventilator charging indicator light)
- ⑤ Locking knob
- ⑥ Unlocked icon
- ⑦ Battery charge status button
- ⑧ Battery charge indicator lights
and battery charge scale

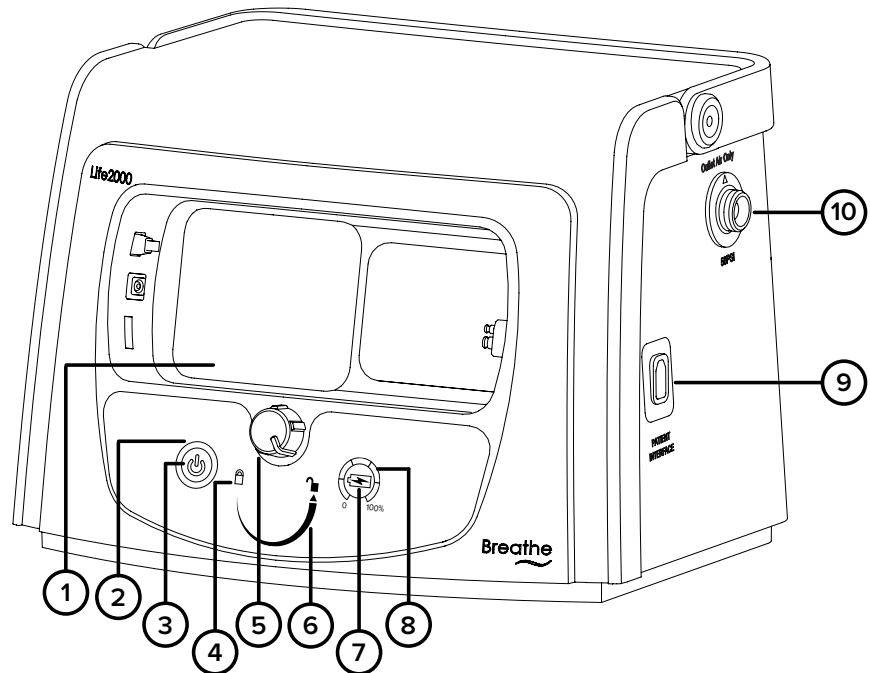

SIDE

- ⑨ Interface connection
- ⑩ Outlet fitting



NOTE The Stationary Configuration is not available with ventilators that are configured with a battery charger dongle.

BACK

- ⑪ Handle
- ⑫ Air inlet and filter
- ⑬ Cooling filter cover
- ⑭ Cooling vents
- ⑮ Condensation tray
- ⑯ Power supply connection and cover

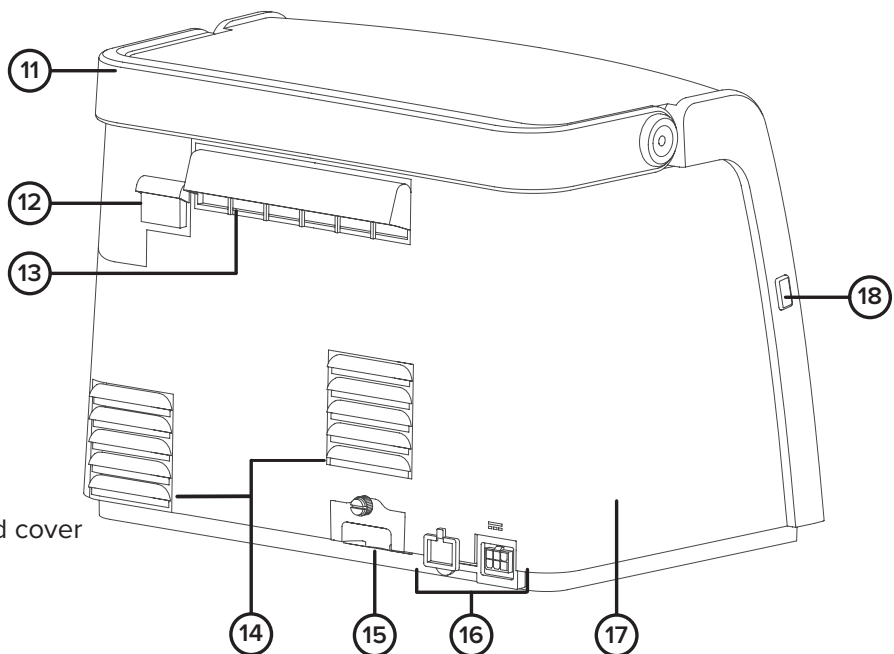

SIDE

- ⑰ Alarm buzzer (internal)
- ⑱ Silence Alarm button

Configurations

The modular Life2000® Ventilation System (system) is composed of the Life2000® Ventilator (ventilator) and the Life2000® Compressor (compressor). The system can be used in three different configurations.

Stationary configuration

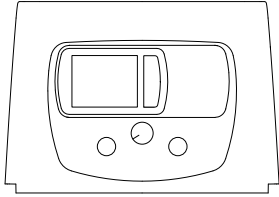

The ventilator is docked into the compressor for ventilation while resting. For information about how to setup the ventilation system in this configuration, see "Stationary configuration" on page 12.

Extended Range (Wearable inside home) configuration

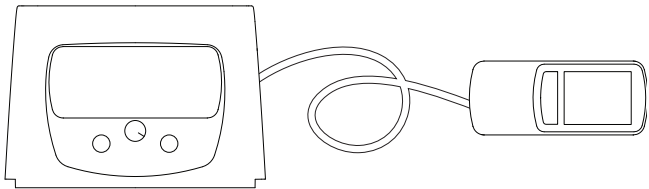

The ventilator is connected to the compressor with a gas supply hose to enable the activities of daily living. For information about how to set up the ventilation system in this configuration, see "Extended Range configuration (Wearable inside home)" on page 20

Stand-Alone (Wearable outside home) configuration

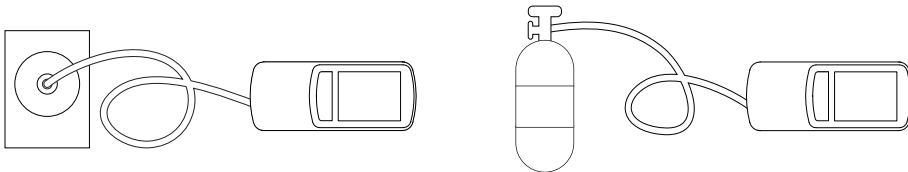

The ventilator is connected to an alternate pressure source such as a hospital wall source or an air or oxygen cylinder. For more information about how to set up the ventilator in this configuration, see "Stand-Alone configuration (Wearable outside home)" on page 33.



NOTE

The Stationary Configuration is not available with ventilators that are configured with a battery charger dongle.

Stationary configuration

Introduction to Stationary configuration

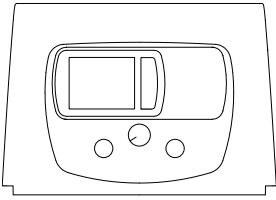

In Stationary configuration, the ventilator is docked into the compressor. The compressor provides the ventilator with a continuous pressure source and functions as a charging station.

Stationary configuration setup checklist

Refer to the chapter contents for full instructions, warnings, and cautions.

- Test the ventilator before using it on a new patient if in multi-patient environment (see section below.)
- Position the compressor.
- Connect the compressor to an AC power source using the compressor's external power supply and AC power cord.
- Dock the ventilator into the compressor.
 -  **TIP:** Check to make sure the ventilator is locked in the compressor.
- Connect an interface to the compressor.

NOTE:

For information about the interface on the patient side, see "Connecting an interface" on page 41.

- Power on the compressor.
- Power on the ventilator.
- Check the compressor's battery charge status.
- Check the ventilator's battery charge.

NOTE:

Ventilation will not begin until an Activity button is pressed on the ventilator. For more information see "Choosing an activity button (Patient selectable) to begin ventilation" on page 65.

Testing the ventilation system

In a multi-patient setting, the ventilation system must be tested before it is assigned to a new patient. For instructions on testing the ventilation system, see "Testing ventilator alarms" on page 123.

Positioning and carrying the compressor

Position the compressor upright on a flat, level surface. Make sure that the cooling vents, cooling filter cover, and air inlet on the back of the compressor are not blocked, and there is sufficient clearance from surrounding objects. Protect the compressor from falling.

The compressor should not be used adjacent to or stacked with other equipment and that if adjacent or stacked use is necessary, the compressor should be observed to verify normal operation in the configuration in which it will be used.

When carrying the compressor, make sure to use the handle, keep the compressor in an upright position, and protect it from falling or dropping.



NOTES

- The compressor outputs an audible sound and must be at least 3 feet (1 m) away from the user during use.
- When operating in a 40°C (104°F) environment, the gas output by the ventilation system may reach temperatures up to 48°C (118.4°F). To reduce patient discomfort, operate the ventilation system in a cooler environment.
- The performance of the compressor may degrade in high temperature, high humidity, or high altitude environments. If degradation is seen, switch to an alternate means of ventilation. Verify the performance of the compressor for adequate therapy delivery in the environment(s) in which it will be used and adjust the volume to compensate for altitude when necessary.
- The ventilator settings might not be achieved when sourced by the Life2000[®] Compressor due to increases in altitude near or above 2500 feet. Consult the table to ensure that the compressor can meet the ventilator settings. The tidal volume delivered to the patient includes the ventilator set volume + entrainment volume from patient interface + supplemental oxygen volume (if used). For additional information see page 159.

Simulated Elevation (in feet)	Observed Maximum Compressor Output (in LPM)
0	17
2500	14
4000	12
8000	8



WARNING:

- Do not use the ventilation system in the presence of flammable anesthetics.
- Do not cover or block the compressor's internal alarm buzzer with any object. Covering the buzzer may make it difficult for a patient or caregiver to hear alarms, which may result in inadequate respiratory therapy.
- Do not cover the ventilator, touch screen, speaker, or backup alarm buzzer with tape or any other object. Covering the ventilator or any of its parts might cause difficulty in hearing alarms and might affect ventilator performance.
- When the ventilator is in use, keep it in a well-ventilated area to prevent it from overheating. The ventilator may overheat and be permanently damaged if it is used in an area that is not well ventilated.
- Do not connect the ventilation system components or accessories to any other equipment that is not described in this Instructions for use.



CAUTION:

- Keep in a clean environment to protect the ventilation system from ingress of dust, lint, and pests.
- Do not leave the ventilation system exposed to the sun or other sources of radiant heat, it may overheat.
- Do not allow children or pets to access the ventilation system; it may become damaged.

Supplying power to the compressor

An AC power cord and external power supply are included with the compressor.

- ① Open the compressor's power supply connection cover.
- ② Insert the compressor's power connector into the power supply connection on the back of the compressor until it clicks into place; the lock tab on the cord will be on the top.
- ③ Connect the AC power cord to the compressor's external power supply and cord.
- ④ Connect the pronged end of the compressor's AC power cord to an AC power source.
- ⑤ Verify that the green LED indicator on the external power supply lights up to indicate the AC connection.

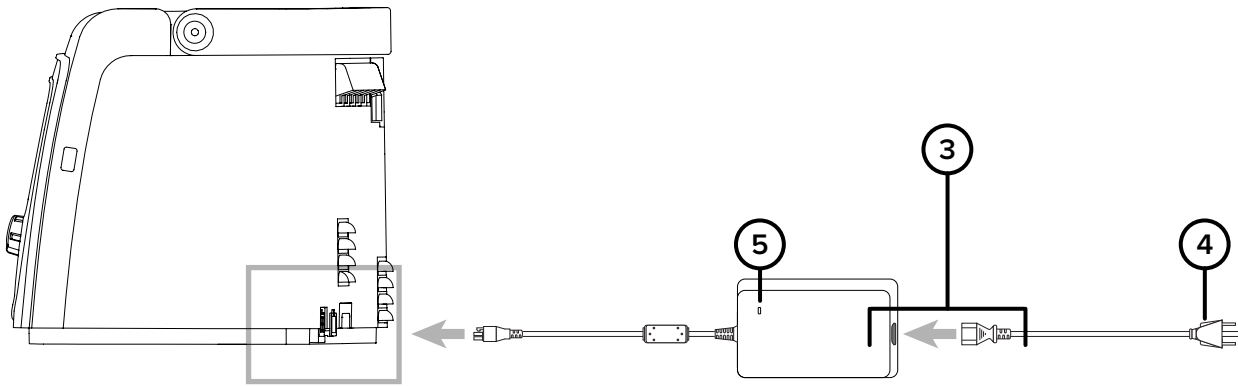
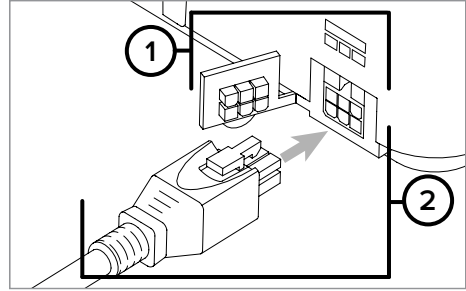

NOTES:

- To remove the power cord from the compressor, press on the end of the lock tab on the external power supply cord and pull to release the cord from the compressor.
- To isolate the compressor from the supply mains (AC power source), unplug the compressor's AC power cord from the AC power source.

TIP:

The compressor's power supply connection is equipped with a protective cover to prevent ingress of water and debris. Use the cover to keep the power supply connection covered when not in use.

WARNING:

The interface, source gas supply hose, and power cords should be positioned to avoid restricting movement, causing a tripping hazard, or posing a strangulation risk.

CAUTION:

- Do not place the compressor's AC power cord or external power supply on wet surfaces or use in wet environments. Wet environments may damage the AC power cord or external power supply and may cause electric shock.
- Use only the approved AC power cord and external power supply with the compressor. Using an unauthorized AC power cord or external power supply may damage the compressor.

Docking the ventilator into the compressor



NOTE:

When switching between ventilation system configurations, ensure that the patient receives adequate ventilation therapy; place the patient on an alternate means of ventilation if necessary.

- 1 Ensure that the ventilator is powered off.



NOTE:

Alarms might be encountered and/or the selected Activity Button might be inadvertently changed if the ventilator is not powered off before docking.

- 2 To dock the ventilator into the compressor, make sure the locking knob is in the unlock position as shown.

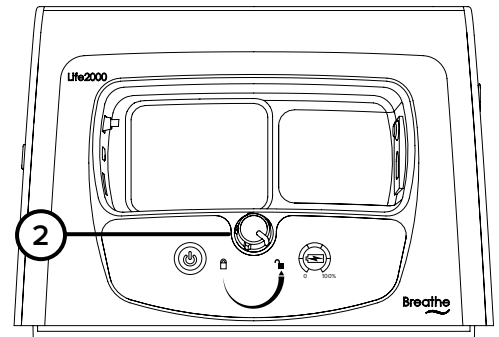
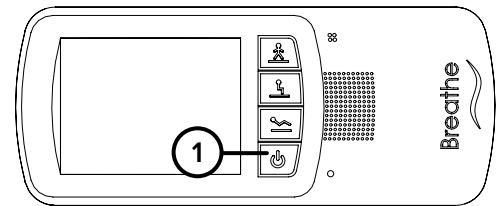

- 3 Position the ventilator into the compressor cradle as shown. Push the ventilator into the compressor in the direction indicated by the arrow until it clicks into place.

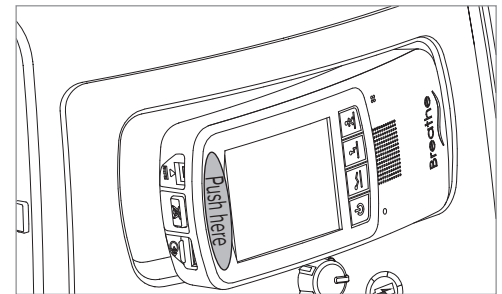

- 4 Gently push the top of the ventilator (in the area indicated) until the front of the ventilator is flush with the front of the compressor and clicks into place.

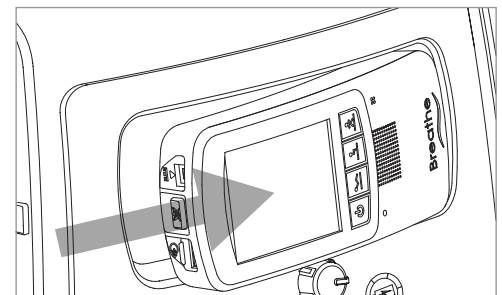

TIP: Avoid pushing directly on the touch screen or buttons.

- 5 Turn the locking knob clockwise to the locked position to lock the ventilator in the compressor.
- 6 When the compressor is on, check that the locked icon lights up (green) to indicate the ventilator is properly docked. When the ventilator is properly docked and locked the ventilator is being charged by the compressor.

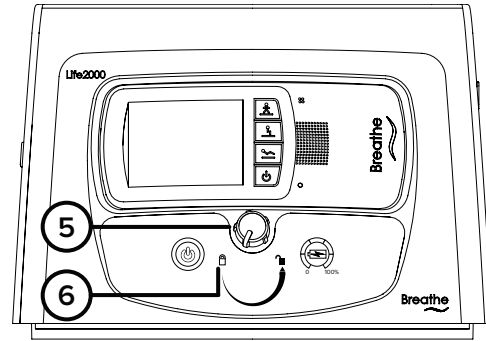

NOTES:

- If the compressor is off and connected to an AC power source, press the battery charge status button on the compressor to illuminate the green locked icon and verify that the ventilator is properly docked.
- If the knob does not lock on first attempt, turn knob slightly counterclockwise and then clockwise again.
- To ensure continuous ventilation, make sure the ventilator battery is being charged by the compressor while the ventilator is docked. For more information see "Battery information" on page 133.

VENTILATOR CHARGING BY COMPRESSOR (WHEN DOCKED AND LOCKED)

	Compressor ON	Compressor OFF
AC CONNECTED to Compressor	Ventilator charging	Ventilator charging
AC DISCONNECTED from Compressor	Ventilator charging	Ventilator DOES NOT charge

NOTE:

The ventilator will not charge when the compressor is powered off and not connected to AC power.

Connecting an interface to the compressor

Plug the Breathe Pillows Entrainment Interface or Universal Circuit® Connector into the interface port on the side of the compressor until it clicks. For more information about wearing interfaces, see "Connecting an interface" on page 41.

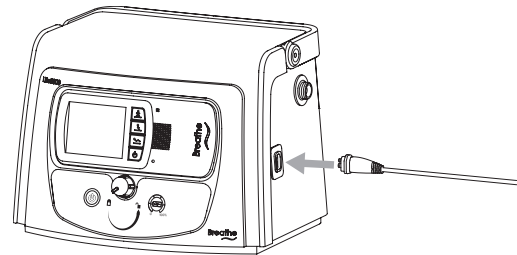

The outlet fitting in Stationary configuration



Do not connect a gas source to the outlet fitting on the compressor.

CAUTION:

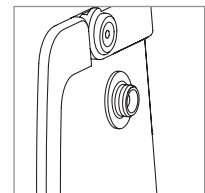
Using the outlet fitting while the Life2000® Ventilation System is delivering therapy in Stationary Configuration might decrease flow to the patient.



Powering on sequence in Stationary configuration

- ① Power on the compressor by pressing the power button for the compressor.
- ② When powered on, lights surrounding the compressor power button will illuminate:
 -  Green indicates the compressor is connected to AC power.
 -  Orange indicates the internal battery is being used.

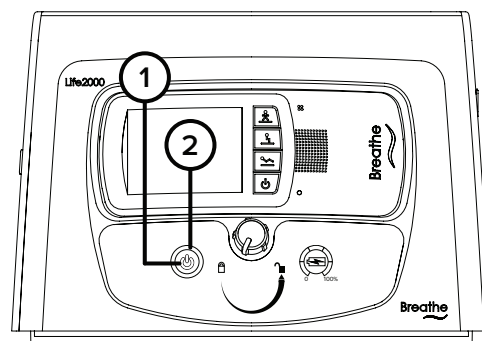

NOTE:

If the ventilator is properly docked, the locked icon will also illuminate when the compressor is powered on.

- ③ Power on the ventilator by pressing the power button for the ventilator.
- ④ Ensure the green power indicator light on the ventilator is on.
- ⑤ When the startup screen is displayed, listen for audible tones to test the ventilator's alarm speaker.

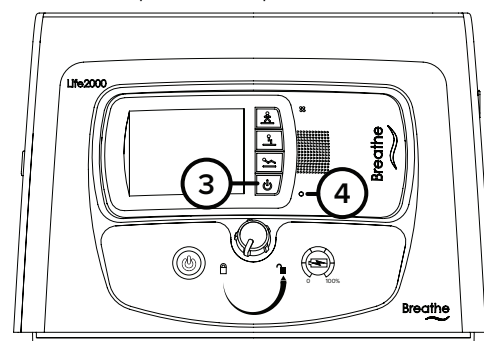

During the ventilator's start up sequence, the ventilator will perform a self-test. During the test, all ventilator indicator lights should briefly flash and an audible alarm should briefly sound. This self test can take up to 15 seconds to complete. If you do not hear tones when you turn on the ventilator, contact your service representative.

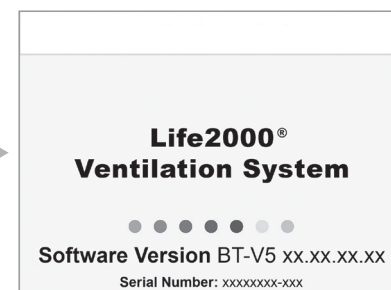
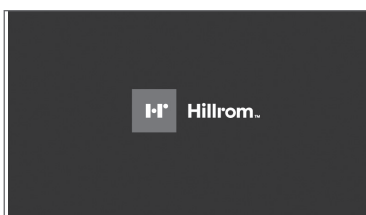

When the **Home** Screen is displayed, the touch screen is ready to use.

NOTE:

Ventilation will not begin until an Activity Button is selected on the ventilator. For more information see "Choosing an activity button (Patient selectable) to begin ventilation" on page 65.

NOTE:

A high-pitched sound may be heard briefly while the compressor is powering on. This sound will go away once the compressor reaches operating pressure.

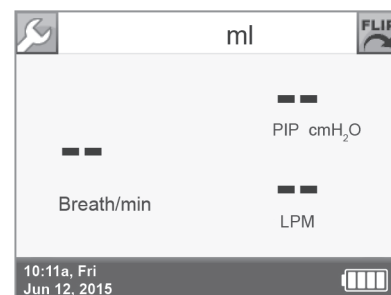

Checking the compressor's internal battery status

The compressor is equipped with an internal battery for temporary AC power disruptions. This internal battery:

- charges when the compressor is attached to AC power.
- has a maximum charge of one hour.

- 1 When the compressor is powered on and the power source indicator lights surrounding the power button are illuminated in orange the compressor is running on its internal battery.
- 2 The battery charge indicator lights and battery charge scale surround the battery charge status button and indicate the compressor's current battery charge level. Consult the charts on the following page to determine the approximate amount of charge on the compressor's internal battery.

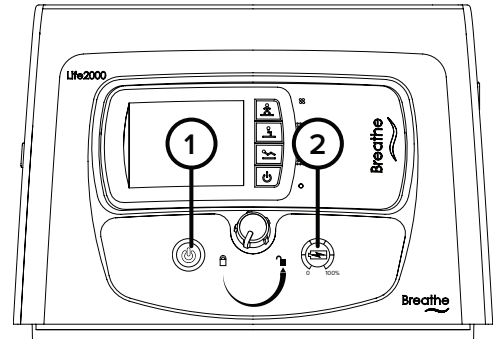

i TIP:

When the compressor is off, press and hold the Battery Charge Status button to display the indicator lights in the battery charge scale.

Silence alarm button on the compressor

Silencing and clearing alarms is a multi-step process that depends on alarm priority and how many alarms are active. For more information see "Alarms, alerts, and troubleshooting" on page 76.

- 1 Press the Silence Alarm button to temporarily silence the alarm for 60 seconds. Pressing the Silence Alarm button silences only one alarm at a time—in audible or vibrating alarm mode. If more than one alarm occurs, press the Silence Alarm button once for each alarm. If the alarm is a medium- or high-priority alarm and is not silenced after 60 seconds, the alarm will continue with an additional buzzer.

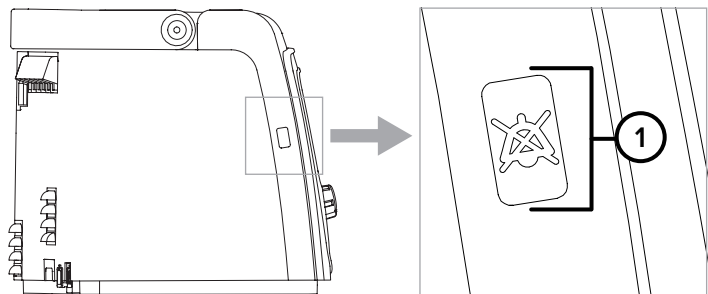

- 2 Resolve the condition that triggered the alarm. For help resolving alarms, see the alarm and troubleshooting tables in "Alarms, alerts, and troubleshooting" on page 76 for possible causes of an alarm and options to resolve it. If an alarm silence button is pressed but the condition that triggered the alarm is not resolved, the alarm will sound again after 60 seconds.

- 3 After resolving a High Temperature, High Circuit Pressure, or High PEEP Pressure high-priority alarm, touch **OK** in the message that indicates the alarm has been resolved.

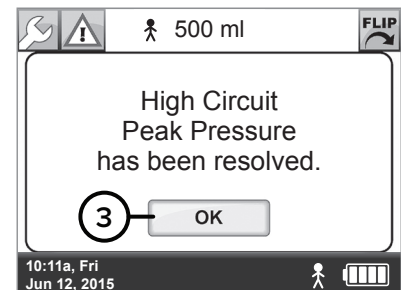

Powering off sequence in Stationary configuration

- ① To power off the ventilator, press the ventilator's power button for three seconds until a confirmation screen appears.
- ② To continue to power off the ventilator, choose **OK**.

 **NOTE:**

If a selection is not made within 20 seconds or if the **BACK** button is selected, the previous screen will be displayed and the ventilation status will not be affected.

- ③ To power off the compressor, press the compressor's power button.

 **NOTE:**

To isolate the compressor from the supply mains (AC power source), unplug the compressor's AC power cord from the AC power source.

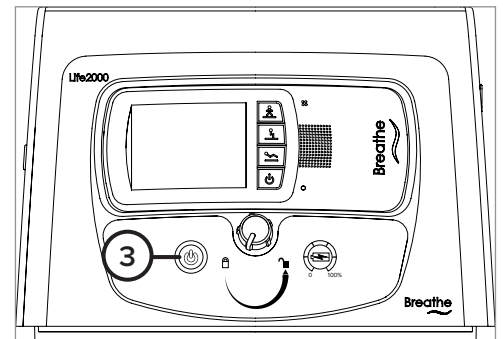
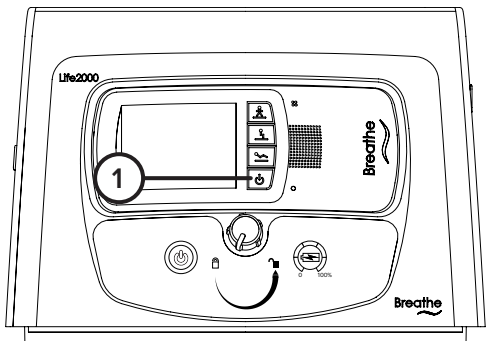

Extended Range configuration (Wearable inside home)

Introduction to Extended Range configuration

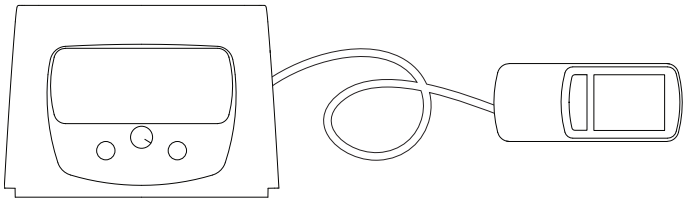

NOTE

Ventilators may not be configured with the Battery Charger Dongle.

The Life2000® Ventilation System can be used in different configurations of operation as the patient's needs change. In Extended Range Configuration, the ventilator is connected to the compressor with an oxygen hose to enable the activities of daily living.

NOTE

If not directly connected to AC power, make sure the ventilator battery has sufficient charge for your length of use.

Extended Range configuration setup checklist

Refer to the chapter contents for full instructions, warnings, and cautions.

- Test the ventilator before using it on a new patient if in multi-patient environment (see section below).
- Position the compressor.
- Connect the compressor to an AC power source using the compressor's external power supply and AC power cord.
- Connect the compressor and the ventilator with an oxygen hose.
- Connect an interface to the ventilator.
- Power on the compressor.
- Power on the ventilator.
- Check the compressor's battery charge status.
- Check the ventilator's battery charge and charge the ventilator, if necessary.
- Secure the ventilator using the belt clip or pole mount.

NOTES

- Ventilation will not begin until an Activity button is pressed on the ventilator. See "Choosing an activity button (Patient selectable) to begin ventilation" on page 65 for more information.
- For information about the interface on the patient side, see "Connecting an interface to the ventilator in Extended Range configuration" on page 24.

Testing the ventilation system

In a multi-patient setting, the ventilation system must be tested before it is assigned to a new patient. For instructions on testing the ventilation system, see "Testing ventilator alarms" on page 123.

Positioning and carrying the compressor

Position the compressor upright on a flat, level surface. Make sure that the cooling vents, cooling filter cover, and air inlet on the back of the compressor are not blocked, and there is sufficient clearance from surrounding objects. Protect the compressor from falling.

The compressor should not be used adjacent to or stacked with other equipment. If adjacent or stacked use is necessary, observe the compressor to verify normal operation in the configuration in which it will be used.

When carrying the compressor, make sure to use the handle, keep the compressor in an upright position, and protect it from falling or dropping.



NOTES

- The compressor outputs an audible sound and must be at least 3 feet (1 m) away from the user during use.
- When operating in a 40°C (104°F) environment, the gas output by the ventilation system may reach temperatures up to 48°C (118.4°F). To reduce patient discomfort, operate the ventilation system in a cooler environment.
- The performance of the compressor may degrade in high temperature, high humidity, or high altitude environments. If degradation is seen, switch to an alternate means of ventilation. Verify the performance of the compressor for adequate therapy delivery in the environment(s) in which it will be used and adjust the volume to compensate for altitude when necessary.
- The ventilator settings might not be achieved when sourced by the Life2000® Compressor due to increases in altitude near or above 2500 feet. Consult the table to ensure that the compressor can meet the ventilator settings. The tidal volume delivered to the patient includes the ventilator set volume + entrainment volume from patient interface + supplemental oxygen volume (if used). For additional information see "Potential Tidal Volumes" on page 159.

Simulated Elevation (in feet)	Observed Maximum Compressor Output (in LPM)
0	17
2500	14
4000	12
8000	8



WARNINGS

- Do not use the ventilation system in the presence of flammable anesthetics.
- Do not cover or block the compressor's internal alarm buzzer with any object. Covering the buzzer may make it difficult for a patient or caregiver to hear alarms, which may result in inadequate respiratory therapy.
- Do not cover the ventilator, touch screen, speaker, or backup alarm buzzer with tape or any other object. Covering the ventilator or any of its parts might cause difficulty in hearing alarms and might affect ventilator performance.
- When the ventilator is in use, keep it in a well-ventilated area to prevent it from overheating. The ventilator may overheat and be permanently damaged if it is used in an area that is not well ventilated.
- Do not connect the ventilation system components or accessories to any other equipment that is not described in this Instructions for use.



CAUTIONS

- Keep in a clean environment to protect the ventilation system from ingress of dust, lint, and pests.
- Do not leave the ventilation system exposed to the sun or other sources of radiant heat, it may overheat.
- Do not allow children or pets to access the ventilation system; it may become damaged.

Supplying power to the compressor

An AC power cord and external power supply are included with the compressor.

- ① Open the compressor's power supply connection cover.
- ② Insert the compressor's power connector into the power supply connection on the back of the compressor until it clicks into place; the lock tab on the cord will be on the top.
- ③ Connect the AC power cord to the compressor's external power supply and cord.
- ④ Connect the pronged end of the compressor's AC power cord to an AC power source.
- ⑤ Verify that the green LED indicator on the external power supply lights up to indicate the AC connection.

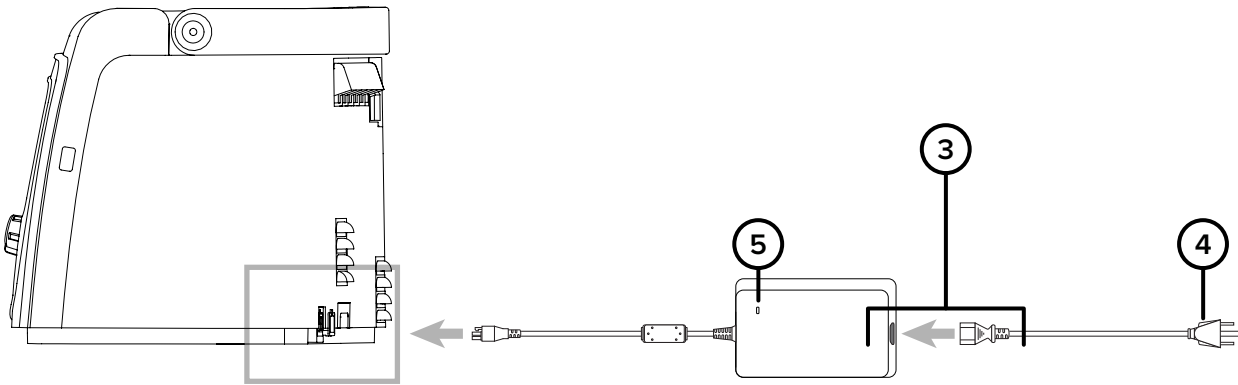
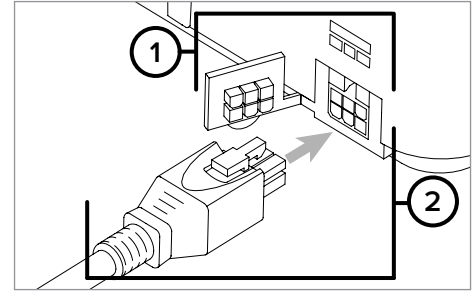

NOTES

- To remove the power cord from the compressor, press on the end of the lock tab on the external power supply cord and pull to release the cord from the compressor.
- To isolate the compressor from the supply mains (AC power source), unplug the compressor's AC power cord from the AC power source.

TIP

The compressor's power supply connection is equipped with a protective cover to prevent ingress of water and debris. Use the cover to keep the power supply connection covered when not in use.

WARNING

The interface, source gas supply hose, and power cords should be positioned to avoid restricting movement, causing a tripping hazard, or posing a strangulation risk.

CAUTIONS

- Do not place the compressor's AC power cord or external power supply on wet surfaces or use in wet environments. Wet environments may damage the AC power cord or external power supply and may cause electric shock.
- Use only the approved AC power cord and external power supply with the compressor. Using an unauthorized AC power cord or external power supply may damage the compressor.

Connecting the ventilator and compressor in Extended Range configuration

In this configuration, the ventilator and compressor are connected by an oxygen hose. A six-foot oxygen hose is included with the ventilation system.

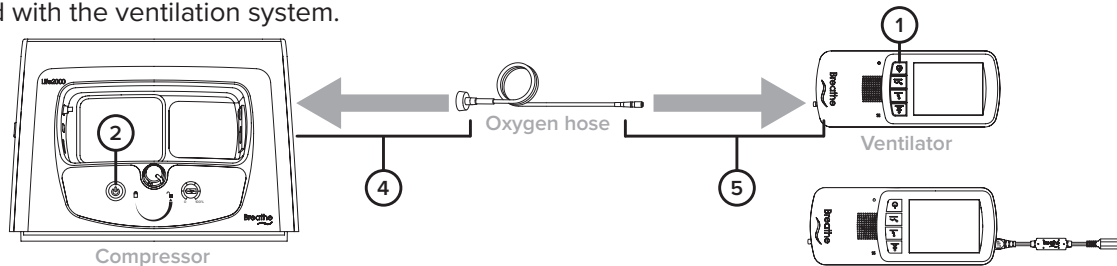

WARNING

The interface, source gas supply hose, and power cords should be positioned to avoid restricting movement, causing a tripping hazard, or posing a strangulation risk.

CAUTION

Use only an approved oxygen hose with the ventilation system.

NOTE

A 20-foot source gas supply hose (available to order) is recommended when using a ventilator output volume greater than 350 ml.

- 1 Ensure the ventilator is powered off.
- 2 The compressor may be powered off or powered on.
- 3 Attach the oxygen hose to the outlet fitting on the compressor.
- 4 Connect the other end of the oxygen hose to the ventilator by pushing the small quick connect end onto the gas inlet connection on the ventilator; when connected, the quick connect end will click into place.

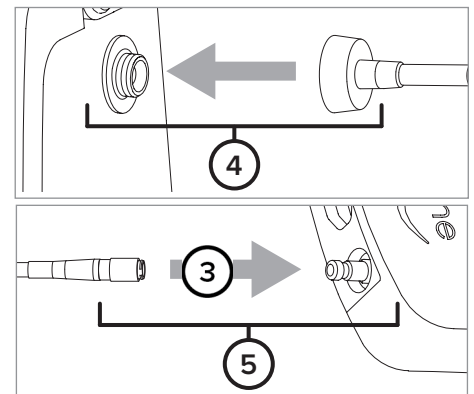

For more information about powering on, see "Powering on sequence in Extended Range configuration" on page 27.

NOTES

- Ventilation will not begin until an Activity button is selected on the ventilator. For more information see "Choosing an activity button (Patient selectable) to begin ventilation" on page 65.
- During use in Extended Range Configuration, the oxygen hose should remain connected to the ventilator at all times, except when required to be disconnected for maintenance, testing, or replacement. If it is disconnected while the ventilator is on and delivering therapy, a Low Gas Pressure alarm will occur. For more information see "Low Gas Pressure" on page 92.
- Alarms might be encountered and/or the selected Activity Button might be inadvertently changed if the ventilator is not powered off.
- The outlet fitting is to be used only for connecting the compressor to the Life2000® Ventilator with an approved source gas supply hose or during the purging of an interface. For more information about the purging process see "Purging the Universal Circuit® Connector" on page 116.

Connecting to a low-flow oxygen concentrator using the CombO₂[®] hose



WARNINGS

- When switching from the Life2000[®] Ventilation System to a standard nasal cannula and oxygen concentrator, confirm that the oxygen flow is set at the prescribed flow rate. Ensure the setting on the oxygen concentrator remains at the prescribed oxygen liter flow while connected to the Life2000 system. Failure to ensure the proper setting may result in inadequate therapy or patient harm.
- When using a low-flow oxygen concentrator with the Life2000[®] Ventilation System, do not modify, extend, or combine multiple oxygen concentrators together. Combining oxygen concentrators to achieve higher oxygen liter flows may result in inadequate oxygen delivery which may cause patient injury.
- Appropriate patient monitoring such as checking oxygen levels with a pulse oximeter should be used as medically indicated when administering supplemental oxygen. The delivered oxygen concentration may vary, depending on the oxygen concentrator specifications, patient volume, and accessories used.
- Hillrom does not manufacture or provide service for low-flow oxygen concentrators. When using a low-flow concentrator with the Life2000[®] Ventilation System, follow the oxygen concentrator manufacturer's user manual for instructions, warnings, and cautions, and/or contact your oxygen provider and care team for instructions for safe use.



NOTES

- Oxygen supplementation can be provided into the Life2000 Ventilation System via third party low flow oxygen concentrators, typically at oxygen flow rates up to 10 LPM. Low flow oxygen concentrators should not be used in patients for whom supplemental oxygenation is life-sustaining or lifesaving. Use other oxygen sources (oxygen cylinders or a wall source) for life-sustaining or life-saving oxygen supplementation.
- When using a low-flow oxygen concentrator, the maximum oxygen flow rate for use with the Breathe Pillows Entrainment Interface is 10 LPM at a maximum pressure of 50 PSI.
- A 20-foot source gas supply hose (available to order) is recommended when using a ventilator output volume greater than 350 ml.
- The outlet fitting is to be used only for connecting the compressor to the Life2000[®] Ventilator with an approved source gas supply hose or during the purging of an interface.

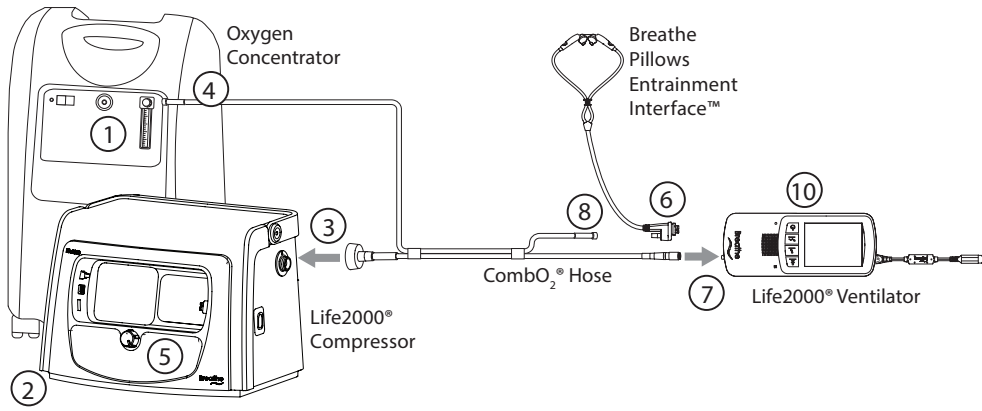

1. Ensure the oxygen concentrator is powered on and the liter flow set to the prescribed level.
2. Place the Life2000® Compressor next to the oxygen concentrator.
3. Attach the outlet fitting connector on the CombO₂® hose to the outlet fitting on the compressor.
4. Attach the corresponding end of the oxygen tubing on the CombO₂® hose to the oxygen concentrator.
5. **Power on the Life2000® System Compressor.**



NOTE

Prior to connecting the CombO₂® hose to the ventilator, ensure the ventilator is powered off to avoid nuisance alarms.

6. Plug the Breathe Pillows Entrainment Interface into the interface port on the end of the ventilator until it clicks.
7. Attach the metal connector on the CombO₂® hose to the ventilator by pushing it onto the metal connection on the ventilator. When connected properly, the metal connector will click into place.
8. Connect the corresponding end of the oxygen tubing on the CombO₂® hose to the open port on the Breathe Pillows Entrainment Interface.
9. Put on Breathe Entrainment Interface. For more information, see Connecting an Interface, "Wearing the Breathe Pillows Entrainment Interface" on page 46.
10. **Power on the ventilator, and select an activity button, to initiate therapy.**





NOTE

Therapy will not begin until an activity button is selected.

11. After confirming the connection to the oxygen concentrator and Life2000® Compressor, touch OK on the ventilator confirmation screen.
12. **After therapy is initiated, verify the oxygen liter flow on the oxygen concentrator remains at the prescribed level.**

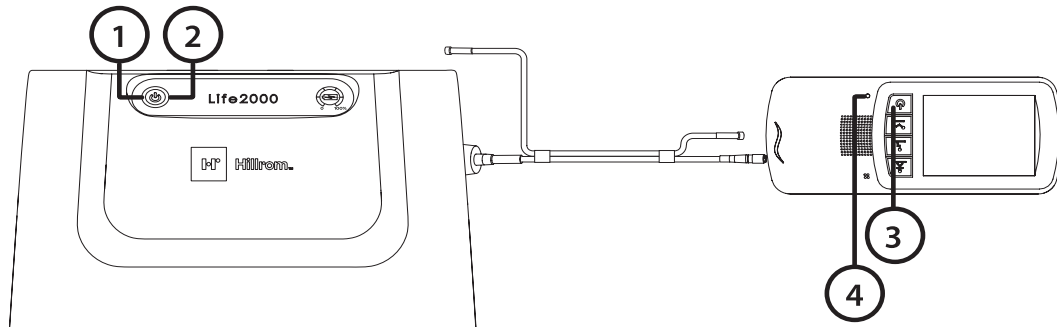
Powering on sequence in Extended Range configuration



- 1 Power on the compressor by pressing the power button.
- 2 When powered on, lights surrounding the compressor power button will illuminate:
 -  Green indicates the compressor is connected to AC power.
 -  Orange indicates the internal battery is being used.
- 3 Power on the ventilator by pressing the power button.
- 4 Ensure that the green power indicator light on the ventilator is on.

When the startup screen is displayed, listen for audible tones to test the ventilator's alarm speaker.

During the ventilator's start up sequence, the ventilator will perform a self test. During the test, all ventilator indicator lights should briefly flash and an audible alarm should briefly sound. This self test can take up to 15 seconds to complete. If you do not hear tones when you turn on the ventilator, contact your service representative.

When the **Home** screen is displayed, the touch screen is ready to use.

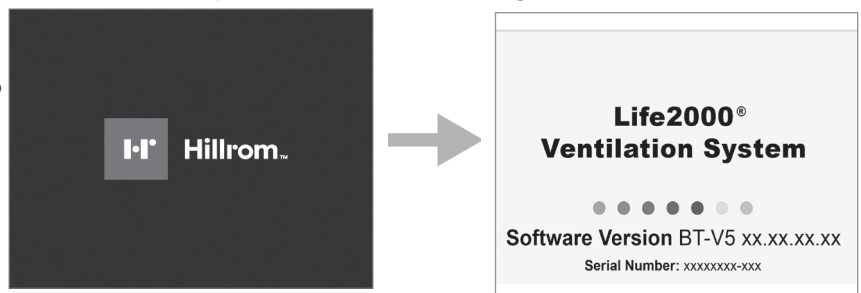

NOTES

- Ventilation will not begin until an Activity button is selected on the ventilator. For more information see "Choosing an activity button (Patient selectable) to begin ventilation" on page 65.
- A high-pitched sound may be heard briefly while the compressor is powering on. This sound will go away once the compressor reaches operating pressure.

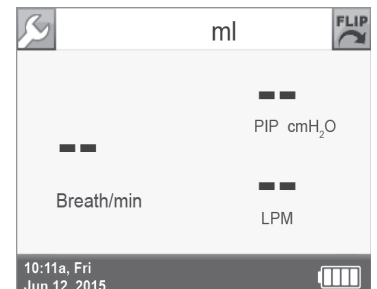

Checking the compressor's internal battery status

The compressor is equipped with an internal battery for temporary AC power disruptions. This internal battery:

- charges when the compressor is attached to AC power.
- has a maximum charge of one hour.

① When the compressor is powered on and the power source indicator lights surrounding the power button are illuminated in orange the compressor is running on its internal battery.

② The battery charge indicator lights and battery charge scale surround the battery charge status button and indicate the compressor's current battery charge level.

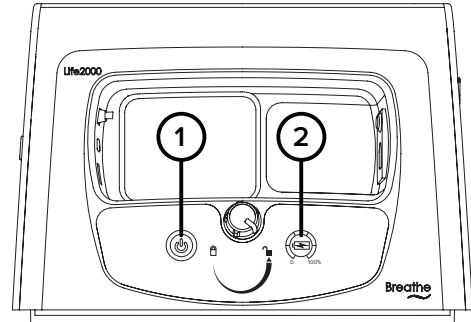

i TIP

When the compressor is off, press and hold the Battery Charge Status button to display the indicator lights in the battery charge scale.

Assembling the ventilator battery charger and charging the ventilator

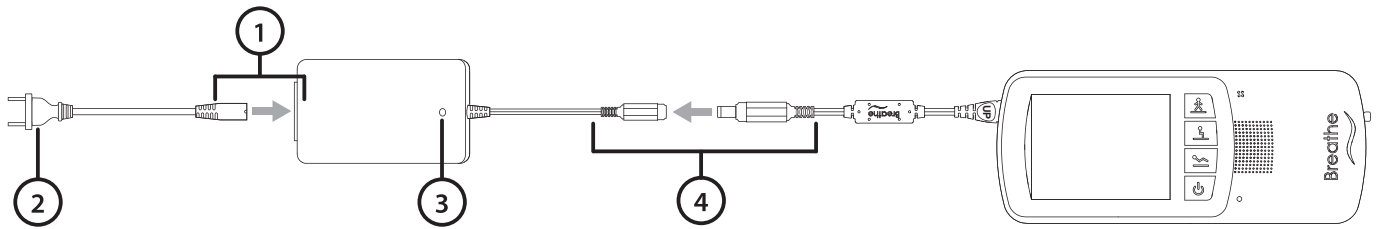

1. Plug the ventilator AC power cord into the ventilator battery charger.
2. Connect the ventilator AC plug into an AC power source.
3. The ventilator battery charger indicator light will turn green or red when connected to AC power.



NOTE

The ventilator can be used while the battery is charging.

4. Connect the ventilator battery charger cord to the ventilator battery charger connector. For devices that are equipped with a dongle, connect the charger to the dongle.
5. If powered on, check the Ventilator Battery Charge icon on the touch screen to see the ventilator's current battery charge status.

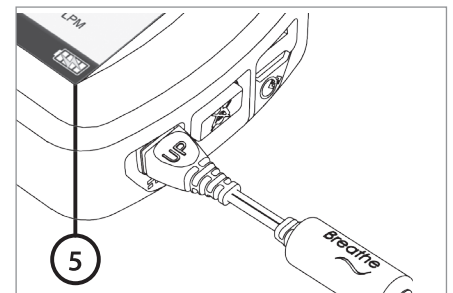

NOTES

- When charging the battery, there may be a delay of up to 20 seconds before the Ventilator Battery Charge icon appears on the touch screen.
- The ventilator performance is the same regardless of power source (internal battery or AC).
- If the battery charger cord is incorrectly inserted, the charger connection may become loose over time.



WARNINGS

- The interface, source gas supply hose, and power cords should be positioned to avoid restricting movement, causing a tripping hazard, or posing a strangulation risk.
- Do not place the battery charger on wet surfaces or use in wet environments. Wet environments may damage the battery charger and may cause electric shock.



CAUTION

- Use only the approved battery charger and cord set with the ventilator. If an unauthorized battery charger or cord set is used with the ventilator, the ventilator may be damaged.

Securing the ventilator belt clip

You can attach the ventilator to a belt or waistband using the included belt clip. The ventilator can be worn on either the right or left side.

CAUTIONS

- Make sure the belt clip is securely fastened to the belt and the ventilator. If the belt clip is not securely fastened to the belt and the ventilator, the ventilator may fall and be damaged.
- Always secure the ventilator to prevent it from falling or becoming damaged.
- Use only the approved belt clip with the ventilator.

1. Position the clip over the belt, and push down until it is secure.

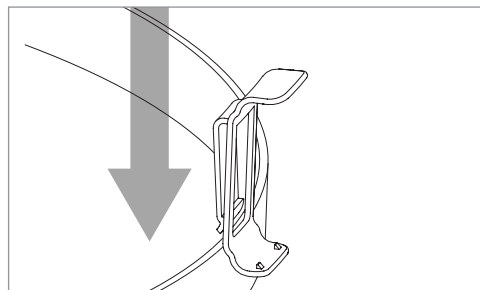

2. Line up the belt clip with the belt clip sockets on the ventilator. Push in the ventilator toward the belt clip until the ventilator audibly clicks into place.

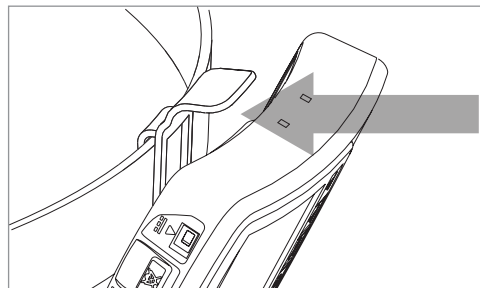

Pole mount

The ventilator may also be secured with the use of an optional pole mount. For more information, see "Pole mount" on page 39.

Ventilator silence alarm button

Silencing and clearing alarms is a multi-step process that depends on alarm priority and how many alarms are active. For more information see "Extended Range configuration (Wearable inside home)" on page 20.

1. Silence Alarm button on ventilator.
2. Press the Silence Alarm button to temporarily silence the alarm for 60 seconds. Pressing the Silence Alarm button silences only one alarm at a time—in audible or vibrating alarm mode. If more than one alarm occurs, press the Silence Alarm button once for each alarm. If the alarm is a medium- or high-priority alarm and is not silenced after 60 seconds, the alarm will continue with an additional buzzer.
3. Resolve the condition that triggered the alarm. For help resolving alarms, see the alarm and troubleshooting tables in "Alarms, alerts, and troubleshooting" on page 76 for possible causes of an alarm and options to resolve it. If a Silence Alarm button is pressed but the condition that triggered the alarm is not resolved, the alarm will sound again after 60 seconds.
4. After resolving a High Temperature, High Circuit Pressure, or High PEEP Pressure high-priority alarm, touch **OK** in the message that indicates the alarm has been resolved.

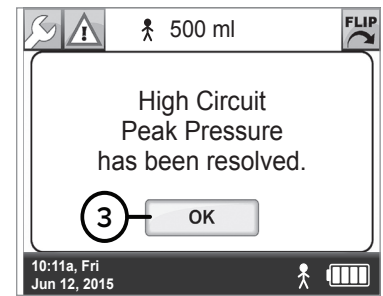
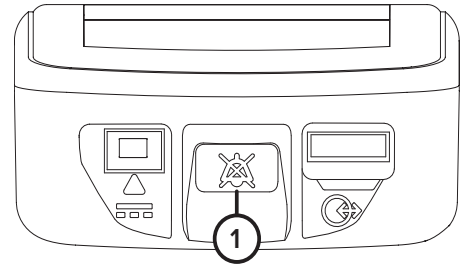

Values displayed on the screen are for illustrative purposes only.

Powering off sequence in Extended Range configuration

1. To power off the ventilator, press the ventilator's power button for three seconds until a confirmation screen appears.

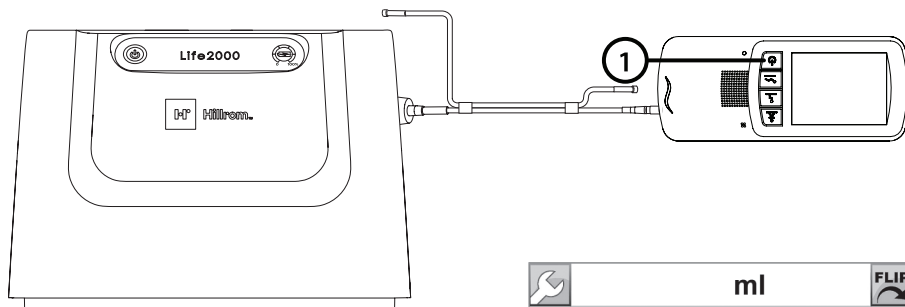

2. To continue to power off the ventilator, touch OK.

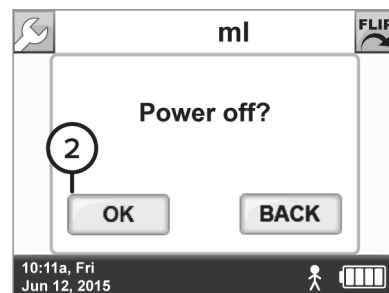

NOTE

If a selection is not made within 20 seconds or if the BACK button is selected, the previous screen will be displayed and the ventilation status will not be affected.

3. To power off the compressor, press the compressor's power button.

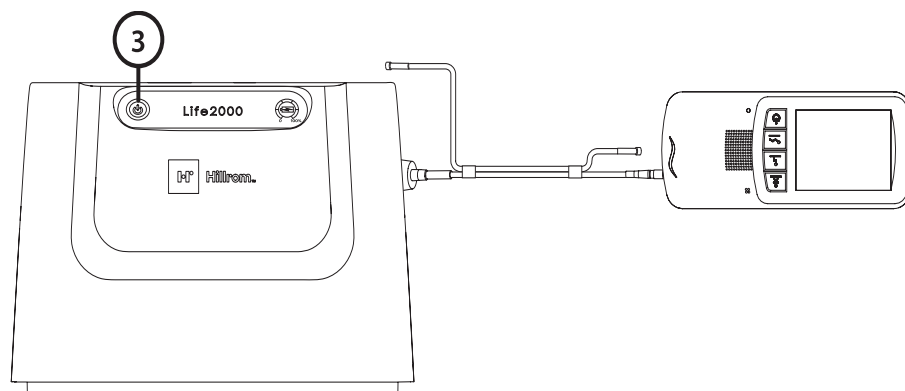

NOTE

To isolate the compressor from the supply mains (AC power source), unplug the compressor's AC power cord from the AC power source.

Disconnecting Extended-Range configuration

1. Power off the ventilator.
2. Disconnect the oxygen hose from the ventilator by pulling back on the knurled ring on the quick connect end of the oxygen hose until the oxygen hose detaches from the ventilator.
3. Disconnect the oxygen hose from the compressor by unscrewing the oxygen hose from the outlet fitting on the compressor.
4. Store the oxygen hose for future use.

Stand-Alone configuration (Wearable outside home)

Introduction to Stand-Alone configuration

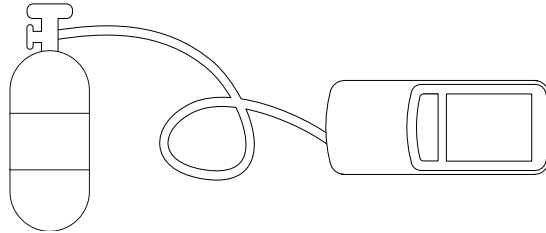

The ventilator requires a pressure source for operation. In Stationary Configuration and Extended Range Configuration, the compressor is the pressure source.

This chapter provides instructions about connecting the Life2000® Ventilator to an alternate pressure source (50-PSI, ≥ 40 LPM at 41 PSI), such as an oxygen cylinder, by using an oxygen hose. A regulator is required to connect the ventilator to an oxygen cylinder.

NOTES

- The ventilator is compatible with medical grade compressed oxygen. Contact your local provider for more information.
- If not connected to AC power, make sure the ventilator battery has sufficient charge for your length of use.
- Always have a backup means of providing compressed gas to the ventilator.
- The responsible organization is responsible for ensuring compatibility of the ventilator and the parts used to connect to the patient before use.

Stand-Alone configuration setup checklist

Refer to the chapter contents for full instructions, warnings, and cautions.

- Test the ventilator before using it on a new patient if in multi-patient environment.
- Connect the ventilator to an oxygen cylinder (and regulator) with an oxygen hose.
- Connect an interface to the ventilator.
- Turn on the oxygen and estimate cylinder duration (see Appendix "Cylinder Duration Information").
- Power on the ventilator.
- Check the ventilator's battery charge and charge the ventilator, if necessary.
- Secure the ventilator using the belt clip or pole mount.

NOTES

- Ventilation will not begin until an Activity button is pressed on the ventilator. For more information see "Choosing an activity button (Patient selectable) to begin ventilation" on page 65.
- For information about the interface on the patient side, see "Connecting an interface" on page 41.

Testing the ventilator

In a multi-patient setting, the ventilator must be tested before it is assigned to a new patient. For instructions on testing the ventilator, see "Testing ventilator alarms" on page 123.

Connecting to a cylinder

An oxygen regulator is required to connect the ventilator to an oxygen cylinder. Ensure that the oxygen regulator meets the requirements below and is appropriate for the cylinder being used.

REGULATOR REQUIREMENTS	
Pressure output	41-87 PSI (50 PSI nominal)
Pressure flow	≥ 40 LPM at ≥ 41 PSI
Pressure fitting	DISS 1240
Flow fitting*	¼" Barb connector
Minimum required selectable flow*	0, 4 (L/min)

* Required for purging only. For more information, see "Purging the Universal Circuit® Connector" on page 116.



WARNINGS

- If the ventilator is not used with a regulator capable of 41 PSI to 87 PSI (nominal 50 PSI) with greater than 40 LPM capability, patients may not receive appropriate respiratory therapy.
- Use the ventilation system with only approved medical compressed oxygen. Use with non-approved sources of oxygen may cause the ventilation system to malfunction and the patient may not receive appropriate respiratory therapy.
- Use only a source gas supply hose with the ventilation system. If an unauthorized source gas supply hose is used with the ventilation system, the system may be damaged.
- Do not use the Life2000® Ventilation System with oxygen in the presence of flammable anesthetics such as fluroxene, cyclopropane, divinyl ether, ethyl chloride, ethyl ether, and ethylene, as they may form flammable or explosive mixtures with oxygen.
- Before beginning ventilation therapy, verify that there is an adequate supply of oxygen for the intended duration of the therapy. Otherwise, the patient may not receive appropriate therapy.
- Do not allow smoking near oxygen sources or near the ventilation system and do not place oxygen sources or the ventilation system near any source of direct heat or open flame because flammable materials burn more readily in the presence of oxygen.
- Do not use the ventilator in the presence of flammable anesthetics.
- The interface, source gas supply hose, and power cords should be positioned to avoid restricting movement, causing a tripping hazard, or posing a strangulation risk.



CAUTION

Follow local regulations and NFPA 55 in the handling and use of oxygen cylinders.



TIPS

- If using a cylinder, make sure your oxygen supply is sufficient for your length of use. For more information about estimating oxygen usage, see "Cylinder Duration Information" on page 156.
- If not connected to AC power, make sure the ventilator battery has sufficient charge for your length of use.
- Refer to the regulator and source gas supply manufacturers' instructions for more information including safety information.
- During use in Stand-Alone Configuration, the oxygen hose should remain connected to the ventilator at all times, except when required to be disconnected for maintenance, testing, or replacement. If it is disconnected while the ventilator is on and delivering therapy, a Low Gas Pressure alarm will occur. For more information see "Low Gas Pressure" on page 92.
- The Life2000® Ventilator can work using most common medical grade oxygen cylinders when using the appropriately-rated regulator. Ensure the appropriate regulator for the cylinder is being used before connecting to the ventilator. Information about the oxygen cylinder and its specific regulator requirements may be found by contacting the oxygen cylinder supplier.

- 1 Choose the appropriate length approved oxygen hose for your needs.

A six-foot oxygen hose is included.

For information about ordering accessories and replacement parts, see "Appendix" on page 155.

- 2 Visually inspect the oxygen hose for damage before using it.

- 3 Ensure the ventilator is powered off.

- 4 Connect the oxygen hose to the ventilator by pushing the small quick connect end of the hose onto the gas inlet connection on the ventilator; when connected, the quick connect end will click into place.

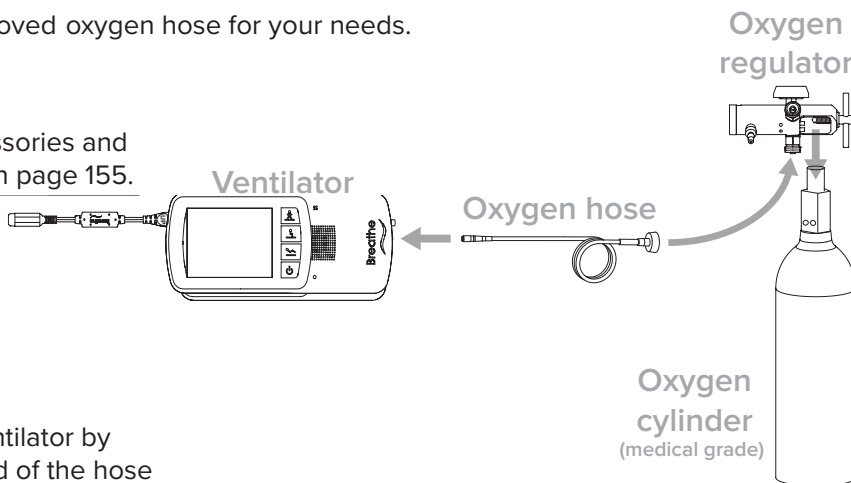

NOTE

To disconnect the oxygen hose from the ventilator, pull back on the quick connect end of the hose.

- 5 Refer to the regulator and oxygen supply manufacturers' instructions for more information about how to connect the cylinder and regulator; the instructions below are provided as an example.

NOTE

If using a cylinder with a built-in regulator, skip to step 9.

- 6 Ensure that the regulator is preset to 50 PSI [or adjust the regulator pressure to 41 PSI to 87 PSI (50 PSI nominal)].

- 7 Slide the regulator over the neck of the cylinder, and line up the pins on the regulator with the holes in the cylinder neck.

- 8 Tighten the tee screw on the regulator by turning the handle clockwise.

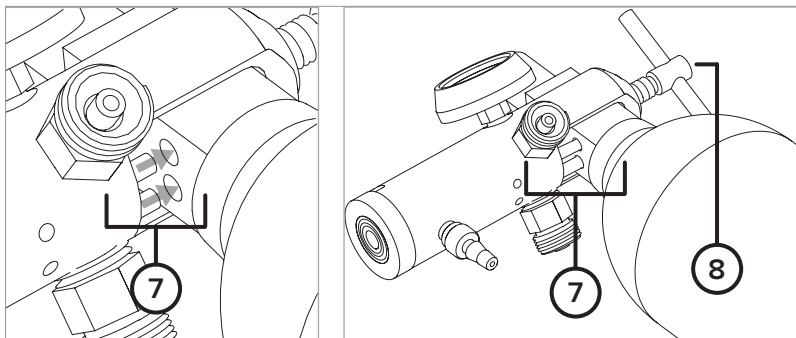

- 9 Connect the oxygen hose to the DISS connector end of the regulator by turning it clockwise.

NOTE

If present, the barbed outlet flow regulator should be set to 0 or OFF during use to conserve your oxygen supply.

- 10 Turn on the oxygen supply according to the regulator and oxygen cylinder manufacturers' instructions. When not in use, turn off the oxygen supply according to the regulator and oxygen supply manufacturers' instructions.

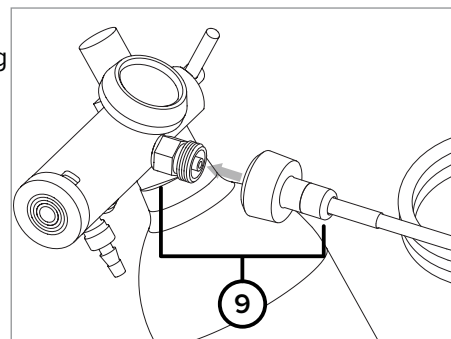

NOTE

For information about estimating the duration of oxygen cylinders and for cylinder replacement instructions, see "Cylinder Duration Information" on page 156.

Connecting an Interface to the ventilator in Stand-Alone configuration

Plug the Breathe Pillows Entrainment Interface or Universal Connector into the interface port on the bottom of the ventilator until it clicks. For more information about wearing interfaces, see "Connecting interface" on page 41.

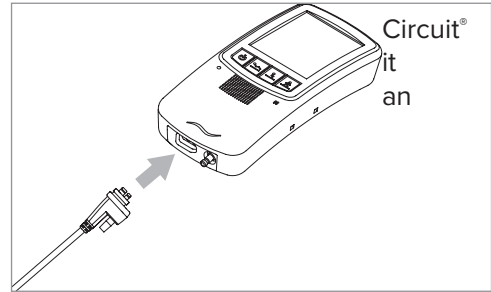

Powering on sequence for the ventilator

- 1 Power on the ventilator by pressing the power button.
- 2 Ensure that the green power indicator light on the ventilator is on.
- 3 When the startup screen is displayed, listen for audible tones to test the ventilator's alarm speaker.

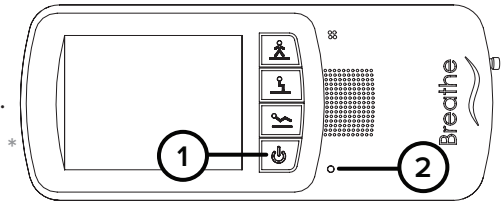

*Ventilators may not be configured with the Battery Charger Dongle.

During the ventilator's startup sequence, the ventilator will perform a self test. During the test, all ventilator indicator lights should briefly flash and an audible alarm should briefly sound. This self test can take up to 15 seconds to complete. If you do not hear tones when you turn on the ventilator, contact your service representative.

When the **Home** screen is displayed, the touch screen is ready to use.

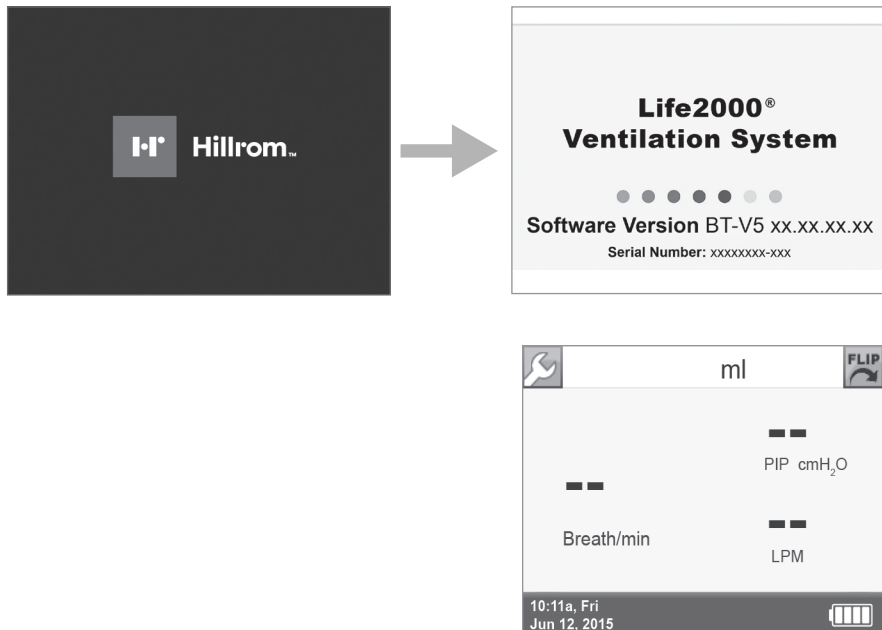

NOTE

Ventilation will not begin until an Activity button is selected on the ventilator. For more information see "Choosing an activity button (Patient selectable) to begin ventilation" on page 65.

Assembling the ventilator battery charger and charging the ventilator

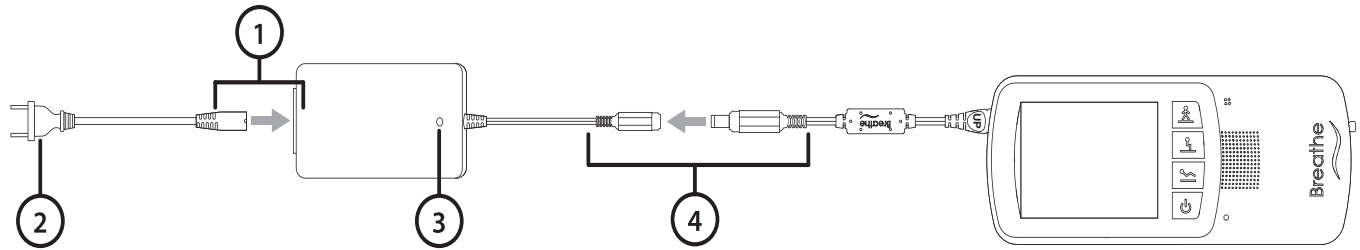

- 1 Plug the ventilator AC power cord into the ventilator battery charger.
- 2 Connect the ventilator AC plug into an AC power source.
- 3 The ventilator battery charger indicator light will turn green or red when connected to AC power.
- 4 Connect the ventilator battery charger cord to the ventilator battery charger connector. For devices that are equipped with a dongle, connect the charger to the dongle.
- 5 If powered on, check the Ventilator Battery Charge icon on the touchscreen to see the ventilator's current battery charge status.

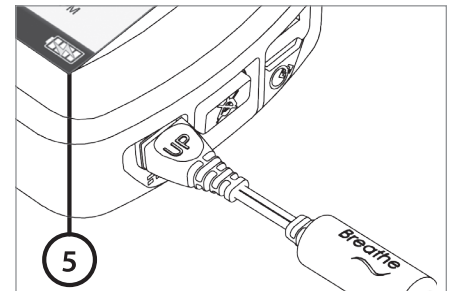

NOTES

- When charging the battery, there may be a delay up to 20 seconds before the Ventilator Battery Charge icon appears on the touch screen.
- The ventilator performance is the same regardless of power source (internal battery or AC).
- If the battery charger cord is incorrectly inserted, the charger connection may become loose over time.
- The ventilator can be used while the battery is charging.



WARNINGS

- The interface, source gas supply hose, and power cords should be positioned to avoid restricting movement, causing a tripping hazard, or posing a strangulation risk.
- Do not place the battery charger on wet surfaces or use in wet environments. Wet environments may damage the battery charger and may cause electric shock.



CAUTION

- Use only the approved battery charger and cord set with the ventilator. If an unauthorized battery charger or cord set is used with the ventilator, the ventilator may be damaged.

Securing the ventilator

Belt clip

You can attach the ventilator to a belt or waistband using the included belt clip. The ventilator can be worn on either the right or left side.

CAUTIONS

- Make sure the clip is securely fastened to the belt and the ventilator. If the clip is not securely fastened to the belt and the ventilator, the ventilator may fall and be damaged.
- Always secure the ventilator to prevent it from falling or becoming damaged.
- Use only the approved belt clip with the ventilator.

① Position the clip over the belt, and push down until it is secure.

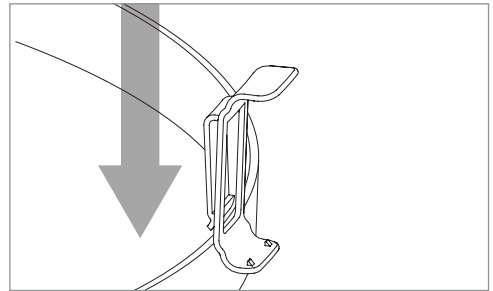

② Line up the belt clip with the belt clip sockets on the ventilator. Push in the ventilator toward the belt clip until the ventilator audibly clicks into place.

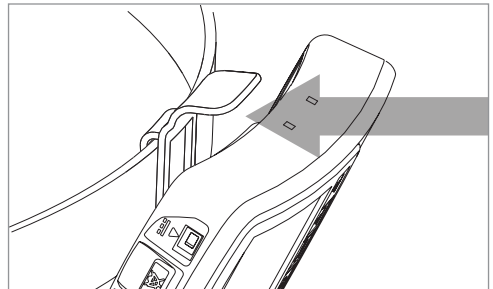

Pole mount

You can attach the ventilator to a pole using an optional pole mount. For information about ordering accessories and replacement parts, see "Appendix" on page 155.

CAUTIONS

- Make sure the pole mount is securely attached to the pole, and the ventilator and clip are securely fastened to the pole mount and the ventilator. If the clip is not securely attached to the pole mount and the ventilator, the ventilator may fall and be damaged.
- Always secure the ventilator to prevent it from falling or becoming damaged.
- Use only the approved belt clip and pole mount with the ventilator.

1 Position the pole mount around the pole in the correct orientation.

2 Turn the knob on the pole mount until the pole mount is securely attached to the pole.

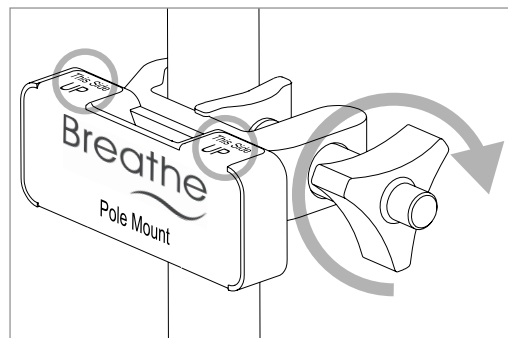

3 Slide the belt clip for the ventilator into the hole on the top of the pole mount and push down until it is secure.

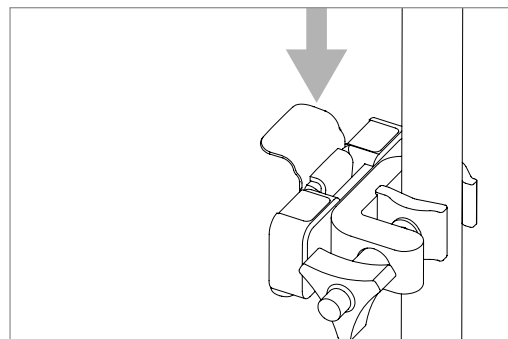

4 Attach the ventilator to the belt clip on the pole mount by lining up the belt clip with the belt clip sockets on the ventilator. Push the ventilator in towards the vent clip and pole mount until the ventilator audibly clicks into place.

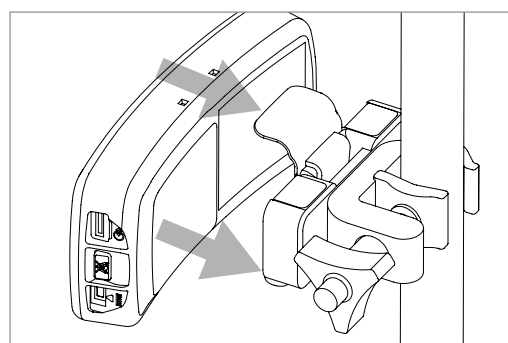

Ventilator Silence Alarm Button

Silencing and clearing alarms is a multi-step process that depends on alarm priority and how many alarms are active. For more information see "Alarms, alerts, and troubleshooting" on page 76.

- 1 Silence Alarm button on ventilator.

Press the Silence Alarm button to temporarily silence the alarm for 60 seconds. Pressing the Silence Alarm button silences only one alarm at a time—in audible or vibrating alarm mode. If more than one alarm occurs, press the Silence Alarm button once for each alarm. If the alarm is a medium- or high-priority alarm and is not silenced after 60 seconds, the alarm will continue with an additional buzzer.

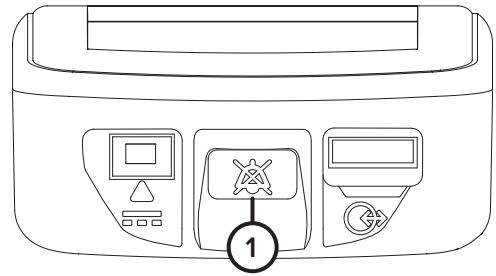

- 2 Resolve the condition that triggered the alarm. For help resolving alarms, see "Alarms, alerts, and troubleshooting" on page 76. If a Silence Alarm button is pressed but the condition that triggered the alarm is not resolved, the alarm will sound again after 60 seconds.

- 3 After resolving a High Temperature, High Circuit Pressure, or High PEEP high-priority alarm, touch **OK** in the message that indicates the alarm has been resolved.

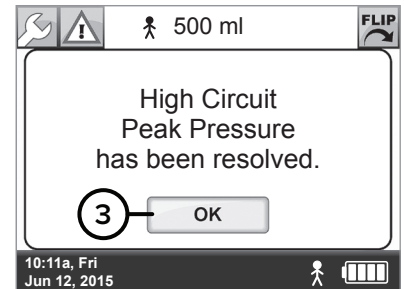

Values displayed on the screen are for illustrative purposes only.

Powering Off Sequence For the Ventilator

- 1 To power off the ventilator, press the ventilator power button for three seconds until a confirmation screen appears.

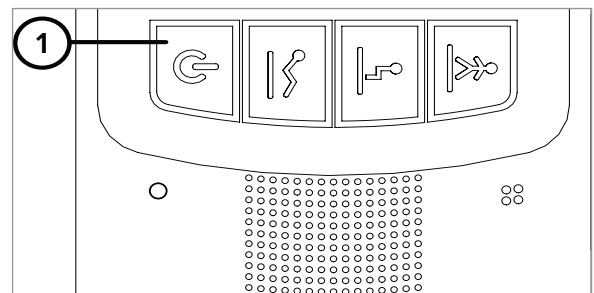

- 2 To continue to power off the ventilator, touch **OK**.

NOTE

If a selection is not made within 20 seconds or if the **BACK** button is selected, the previous screen will be displayed and the ventilation status will not be affected.

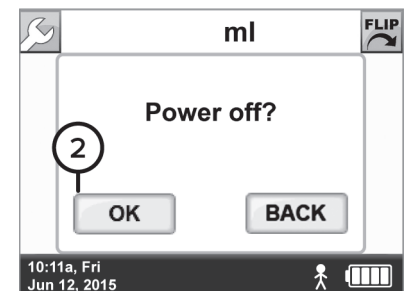

Connecting an interface

The Breathe Interfaces

The Life2000® Ventilation System requires the use of either the Universal Circuit® Connector or Breathe Pillows Entrainment Interface. Breathe interfaces are only compatible with Hillrom™ ventilators and compressors.

The Universal Circuit® Connector is used to connect any commercially available non-invasive mask (full face, nasal, or pillows) or tracheostomy tube to a Hillrom™ ventilator or compressor.

The Breathe Pillows Entrainment Interface is a non-invasive patient mask that connects directly to a Hillrom™ ventilator or compressor.



NOTES

- For information about ordering accessories and replacement parts, see "Appendix" on page 155.
- Before using an interface, visually inspect it for damage.

Connecting an interface to the ventilator in Stationary, Extended Range, or Stand-Alone configuration

Plug the Breathe Pillows Entrainment Interface or Universal Circuit® Connector into the interface connection on the bottom of the ventilator until it clicks.

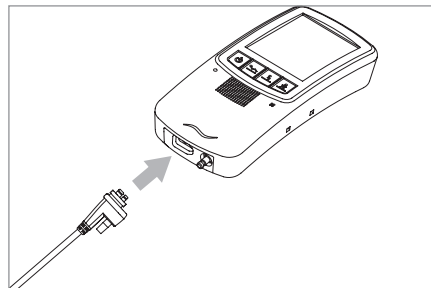

The Universal Circuit® Connector

The Universal Circuit® Connector is used to connect any commercially available non-invasive mask (full face, nasal, or pillows) or tracheostomy tube to a Life2000® ventilator or compressor.

The Universal Circuit® Connector is only compatible with Life2000® ventilators and compressors.

NOTE

The interface assembly is packaged clean but not sterile. The Universal Circuit® Connector does not need to be cleaned or sterilized prior to first use.

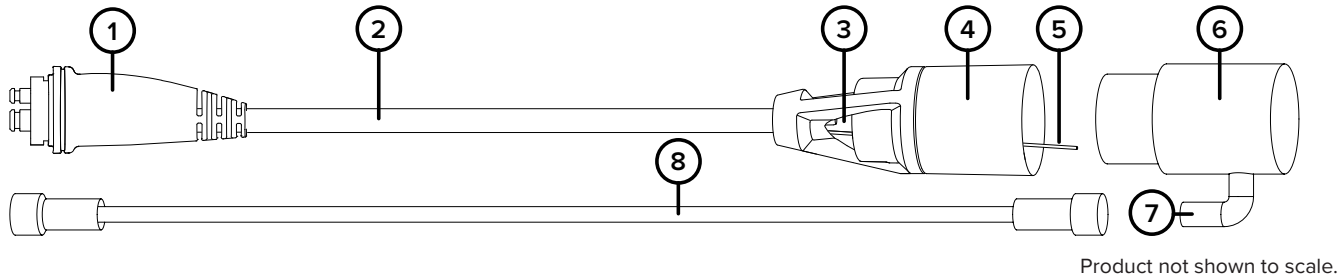

Universal Circuit® Connector (available separately)

- ① Compressor or ventilator connector
- ② Interface tubing
- ③ Entrainment ports
- ④ Universal Circuit® Connector (patient side)
- ⑤ Sense tube

Oxygen adapter

- ⑥ Oxygen adapter
- ⑦ Barb connection
- ⑧ Oxygen tubing

WARNINGS

- The Universal Circuit® Connector is designed for single-patient use. To prevent risk of cross-contamination use a new Universal Circuit® Connector for each new patient. For the third-party mask or tube, refer to the user guide provided by the manufacturer.
- The interface, source gas supply hose, and power cords should be positioned to avoid restricting movement, causing a tripping hazard, or posing a strangulation risk.

CAUTION

A 90-day replacement schedule for the Universal Circuit® Connector is recommended.

NOTE

The Life2000® has been validated for use with a Bacterial Filter or a Heat and Moisture Exchanger (HME) with resistance up to 1.8 cmH₂O at 60 LPM of flow. Always monitor performance of ventilator and alarms when introducing new components into the system.

Examples of Patient Mask and Tube Connections

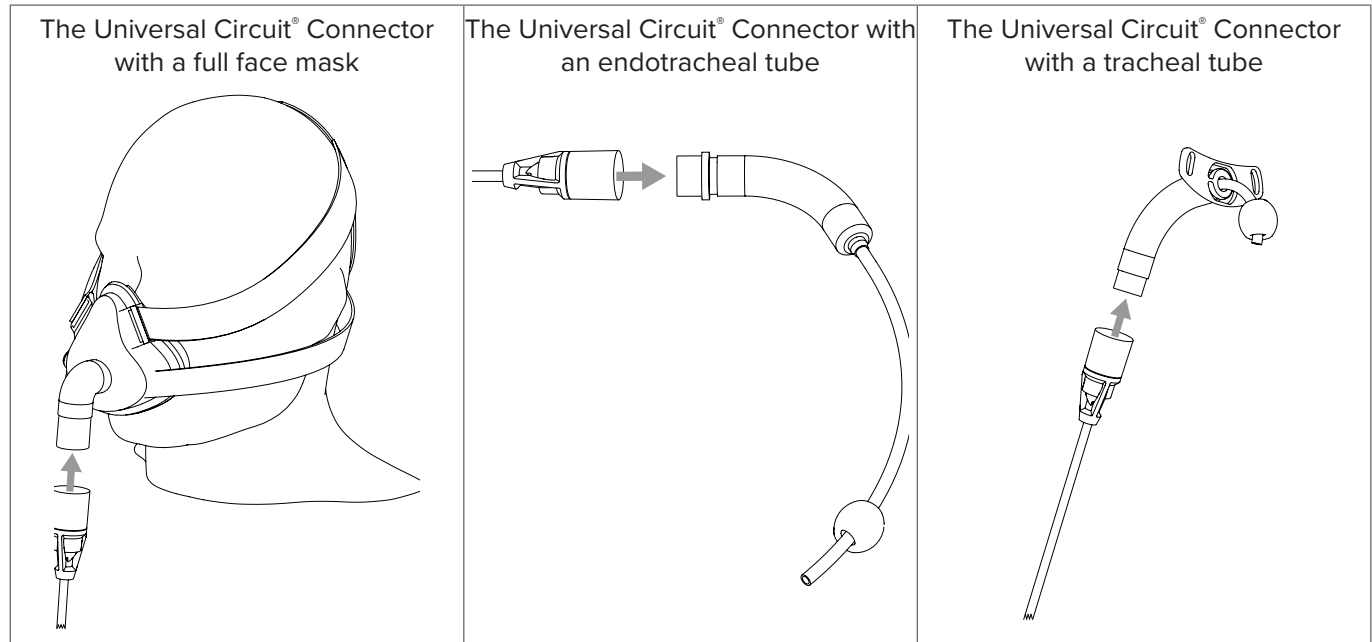

Using the Life2000® Compressor with the Universal Circuit Connector and mask

The Life2000® Compressor is the primary pressure source driving the Life2000® Ventilator. When interfaced with a vented full face mask the compressor is capable of providing enough flow to support PEEP settings less than or equal to 7 cmH₂O. For PEEP settings greater than 7 cmH₂O it is recommended to use an alternate 50 PSI pressure source.

The potential minute ventilation available for the corresponding set PEEP level on the Life2000® Ventilator using the Life2000® Compressor as the primary pressure source are shown in the following table. **The table can be used to obtain approximate values only.**

The potential patient minute ventilation chart is derived from a combination of the PEEP setting and the required flow in LPM to drive the system. It is further influenced by the patient's resistance, compliance, and effort.

PEEP (cmH ₂ O)	APPROXIMATE AVAILABLE MINUTE VENTILATION
1	39.15
2	32.85
3	28.00
4	23.85
5	20.45
6	17.65
7	14.65

Connecting the Universal Circuit® Connector to the oxygen adapter and patient mask or tube

CAUTIONS

- A 90-day replacement schedule for the Universal Circuit® Connector and interface accessories is recommended.
- Do not use a Universal Circuit® Connector, oxygen adapter, or oxygen tubing that is cracked, odorous, broken, or kinked. If a damaged interface is used, the patient may not receive adequate respiratory therapy.

- 1 Place the oxygen adapter between the Universal Circuit® Connector and the third-party patient mask or tube connection. Your mask or tube connection may differ (a full face mask connection is shown as an example).

NOTE

Before using the interface and oxygen adapter, visually inspect them for damage.

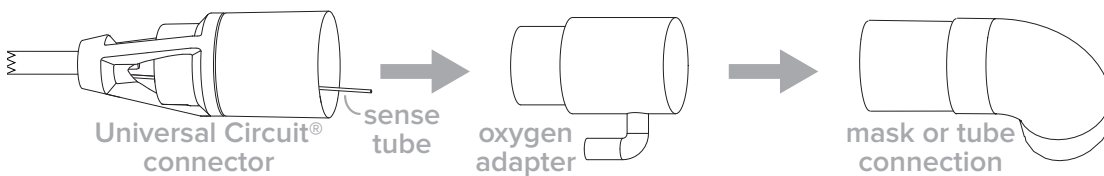

- 2 Connect the Universal Circuit® Connector to the oxygen adapter, ensuring that the sense tube does not become kinked or pinched.
- 3 Connect the oxygen adapter to the third-party patient mask or tube connection.
- 4 Ensure that the entrainment ports are clear of any obstruction and are not covered by any clothing or bedding.

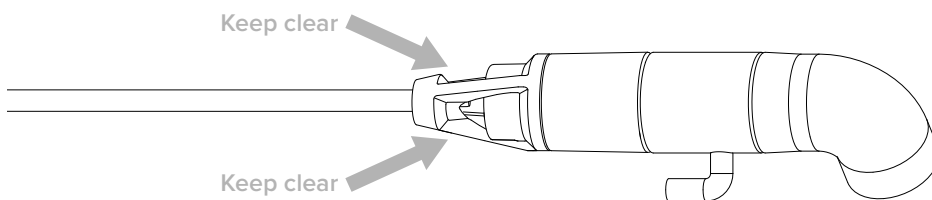

Breathe Pillows Entrainment Interface

Before using the Breathe Pillows Entrainment Interface, visually inspect it for damage.

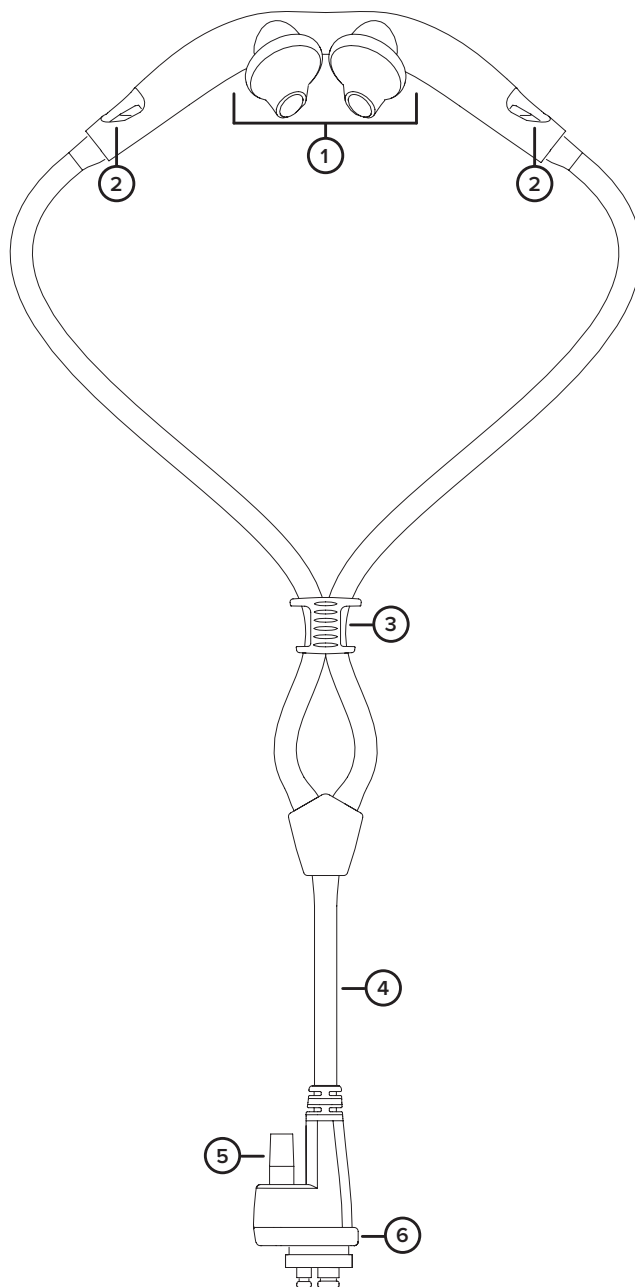

Breathe Pillows Entrainment Interface

- ① Nasal pillows (patient side)
- ② Entrainment ports
- ③ Tube fit adjuster (cinch)
- ④ Interface tubing
- ⑤ Oxygen tubing connection (*)
- ⑥ Compressor or ventilator connector

Required, but not included: (*)

CombO₂® hose or third-party oxygen tubing (e.g., Salter Labs® Oxygen Tubing).

⚠ CAUTIONS

- Do not use a Breathe Pillows Entrainment Interface that is cracked, odorous, broken, or kinked. If a damaged interface is used, the patient may not receive adequate respiratory therapy.
- Recommended 90-day replacement schedule for the Breathe Pillows Entrainment Interface.

⚠ WARNINGS

- Properly secure the Breathe Pillows Entrainment Interface to the face and route tubing around the ears to avoid strangulation.
- The Breathe Pillows Entrainment Interface is designed for single-patient use. To prevent risk of cross-contamination use a new Breathe Pillows Entrainment Interface for each new patient.

* Product not shown to scale.



NOTES

- Do not use the Breathe Pillows Entrainment Interface if the package seal is broken.
- The Breathe Pillows Entrainment Interface assembly is packaged clean but not sterile.
- The Breathe Pillows Entrainment Interface does not need to be cleaned or sterilized prior to first use.

Wearing the Breathe Pillows Entrainment Interface

- 1 Place the interface in front of the patient with the curve of the Interface toward the patient's face and the entrainment ports facing up.

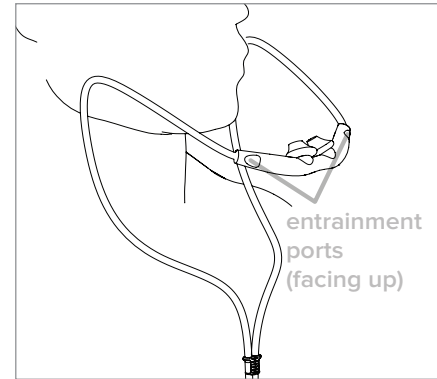

- 2 Loop the interface tubing over the ears and position the nasal pillows snugly inside the nostrils (see below).

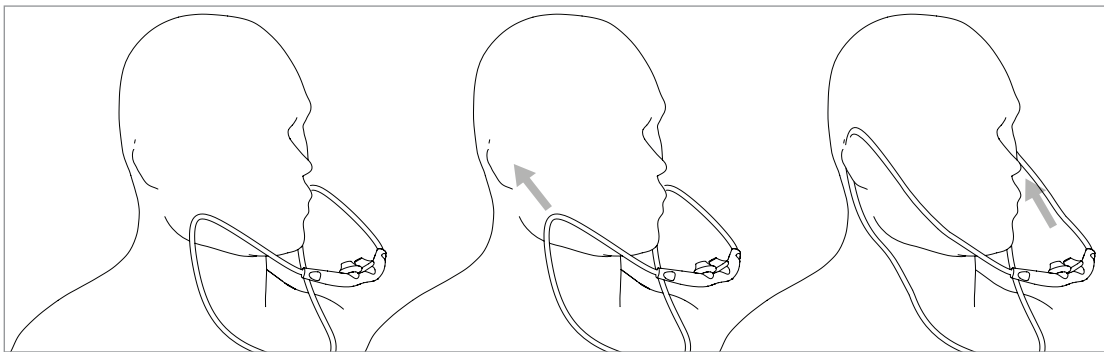

- 3 Using the tube fit adjuster (cinch), adjust the tubing length under the chin so that the interface is secured snugly and comfortably.

! WARNING

Properly secure the interface to the face and route tubing around the ears to avoid strangulation.

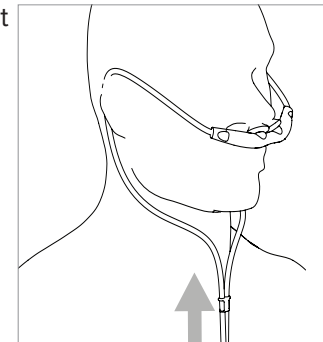

Checking the Breathe Pillows Entrainment Interface positioning

The interface is placed correctly when:

- The interface pillows rest snugly inside the nostrils, as shown.
- The fit is comfortable.
- The interface does not make breathing difficult.
- Air does not flow to the eyes, cheeks, or lips.
- Entrainment ports are not obstructed.

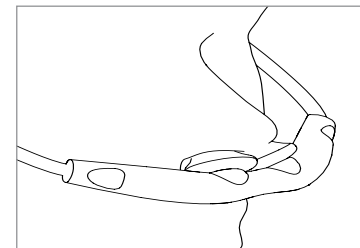

If any one of these conditions is not met, reposition the interface. If problems persist, try a different interface size.

i TIP

When the interface is in use, periodically check that it is positioned correctly and make adjustments as required. If the patient's skin becomes irritated, replace or discontinue using the interface.

Ventilation settings

Introduction to ventilation settings

All of the clinical and utility menus can be accessed, viewed, and edited by the touch screen on the ventilator.

To use the touch screen, simply touch a button or an area of the screen you want to make active. An audible click indicates the feature you touch is activated.

Home screen

When the ventilator is powered on, it completes a self test and then displays the **Home** screen. This screen indicates that the ventilator is ready for use.

When an Activity button is selected on the ventilator, the **Home** screen will display the breath rate (**Breath/min** or **BPM**), Peak Inspiratory Pressure (**PIP cmH₂O**), and gas flow rate (**Air LPM** or **O₂ LPM**).

- ① The **Wrench** button is used to go to the **Menu** screen.
- ② The current **Activity** icon and **Output Volume** (displayed on the **Home** screen during ventilation)
- ③ The **Flip** button flips the screen 180°.
- ④ Peak Inspiratory Pressure (**PIP cmH₂O**) indicator (displayed on the **Home Screen** during ventilation)
- ⑤ Current breath rate (**Breath/min** or **BPM**) (displayed on the **Home Screen** during ventilation)
- ⑥ Average gas flow in liters per minute (**Air LPM** or **O₂ LPM**) based on prescription and patient's current breath rate (displayed on the **Home Screen** during ventilation)

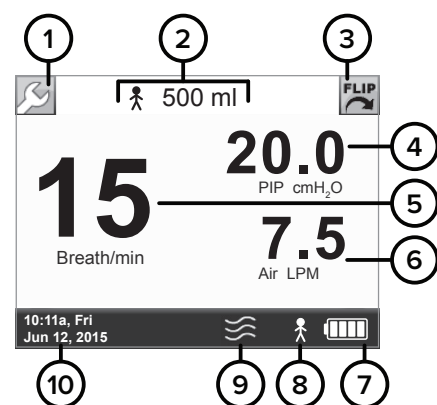
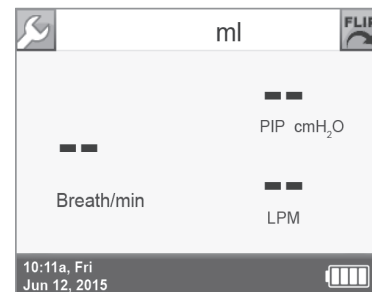

Values displayed on the screen are for illustrative purposes only.

NOTE

The **Home Screen** will initially display **LPM** when the ventilator is first powered on. After an Activity Button is selected and ventilation begins, the **Home Screen** will display **Air LPM** or **O₂ LPM** based on the option prescribed and selected.

- ⑦ **Battery Charge** icon.
- ⑧ Current **Activity** icon (displayed during ventilation).
- ⑨ The **Vibration** icon indicates that the ventilator is set for vibration.
- ⑩ Time and date.

Moving between the home screen and menu screen

- 1 Touch the **Wrench** button to go to the **Menu** screen.

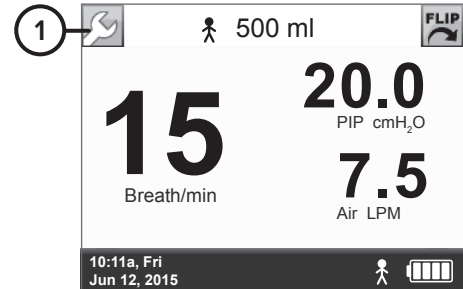

Values displayed on the screen are for illustrative purposes only.

- 2 Touch the **Home** screen button to go to the **Home** screen.

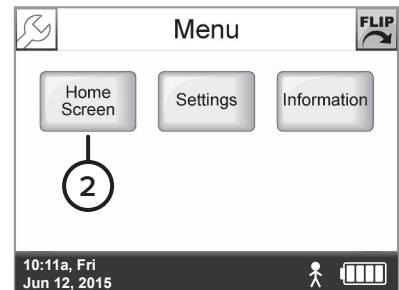

Menu screen

Use the **Menu** screen to access the **Settings** screen or **Information** screen (including software version and total operating time), or go back to the **Home** screen.

To get to the **Menu** screen, touch the **Wrench** button from any screen.

- 1 Screen title.
- 2 Touch to go to the **Home** screen.
- 3 Touch to go to the **Settings** screen for **Trigger Sensitivity**, **Clinician's Settings**, and **Utilities**.
- 4 Touch to go to the **Information** screen.

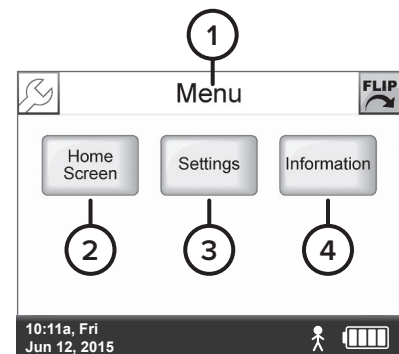

Touch screen energy-save mode

After two minutes with no user interaction, the touch screen automatically enters energy-save mode and dims the screen. Touching the screen again will reactivate it and display the **Home** screen.

Defining clinical settings

NOTE

For facilities where trained healthcare professionals are the intended users, the password to access clinical settings may be enabled or disabled. For more information, contact customer service.

Accessing the settings menu

- 1 On any screen, touch the **Wrench** button.

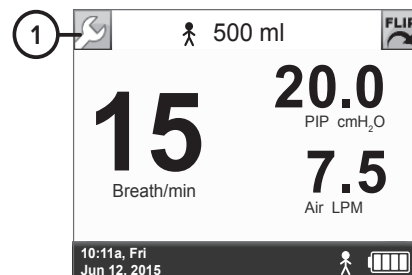

Values displayed on the screen are for illustrative purposes only.

- 2 On the **Menu** screen, touch **Settings**.

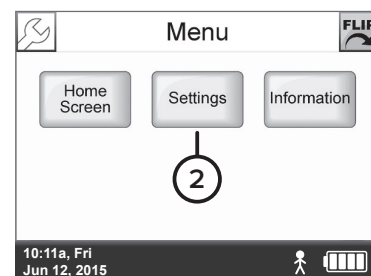

Accessing the clinician's settings menu

- 1 On the **Settings Menu** screen, touch **Clinician's Settings**.

NOTE

Access to the **Clinician's Settings** menu is restricted to trained clinical personnel.

- 2 On the **Clinician Password** screen, enter the password.

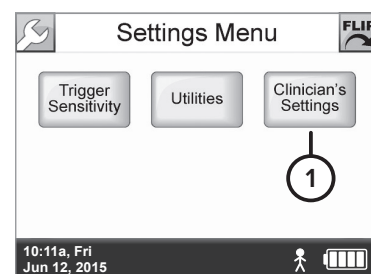

- 3 Touch **OK** to access the **Clinician's Settings**.

NOTE

To obtain the Clinician Password contact customer service.

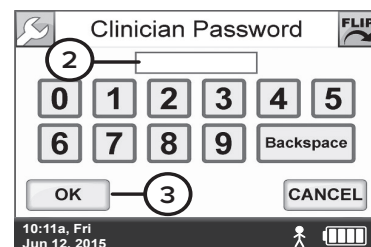

Disabling access to the clinician's settings menu

There are two ways to disable access to the **Clinician's Settings** menu to prevent unintended changes to the programmed clinical settings.

Automatic timeout

An Automatic Timeout disables access to the **Clinician's Settings** menu after five minutes of inactivity in the **Clinician's Settings** menu.

The password must be re-entered to regain access to the **Clinician's Settings** menu.



NOTE

Automatic Timeout begins after the Touch Screen Energy-Save Mode. For more information, see "Touch screen energy-save mode" on page 48.

Powering off

Powering off the ventilator will also disable access to the **Clinician's Settings** menu; when the ventilator is powered on again, the password must be re-entered to access the **Clinician's Settings** menu.

Prescription settings

Each **Activity** icon on a button in the **Prescription Settings** screen represents a prescription that can be programmed by a clinician and made available to the patient.

Each button on the **Prescription Settings** screen corresponds to an Activity button on the ventilator. Program one, two, or all three of the ventilator's Activity buttons by editing the **Prescription Settings**. To make the Activity buttons available for patient selection on the ventilator, activate them by checking the boxes underneath the corresponding **Activity** icon on the **Prescription Settings** screen.

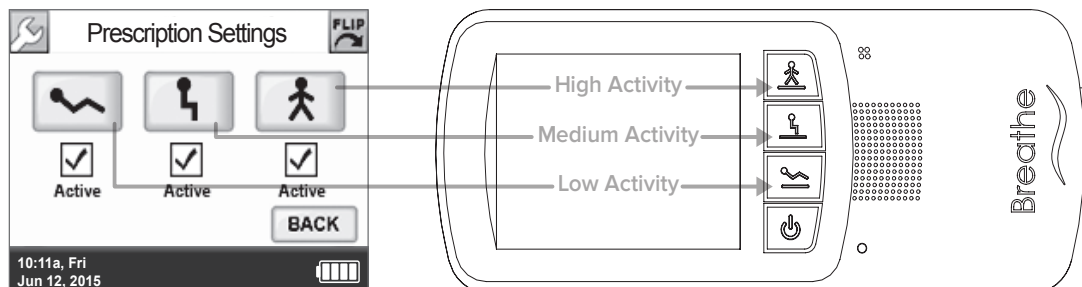

*Ventilators may not be configured with the Battery Charger Dongle.

Editing prescription settings

- 1 Select the button on the **Prescription Settings** screen representing the prescription you want to edit.

NOTES

- The button on the **Prescription Settings** screen does not need to be checked to edit the prescription (a checked box means this prescription is available for selection by the patient).
- The **BACK** button on the **Prescriptions Setting** screen is used to return to the **Settings** menu screen.

TIP

The ventilator is shipped with factory-set default values. Be sure to adjust the **Prescription Settings** based on a physician's order.

- 2 The **Activity** icon at the top of the screen indicates which prescription is being edited.
- 3 For each of the three prescriptions that may be made available to the patient (the **Low Activity** icon is shown for illustrative purposes here), set up **Ventilation Settings**, **Alarm Limits**, **Breath Timeout**, and **Source Gas** parameters according to a physician's order.

NOTE

See the following pages for additional information about setting up these parameters.

- 4 Use the **BACK** button to return to the **Prescription Settings** screen to view or edit other settings.

NOTE

Editing a prescription setting does not make the prescription available to the patient. The box underneath the corresponding **Activity** icon on the **Prescription Settings** screen must also be checked for the prescription to be available for selection by the patient. See "Activating prescription settings" on page 52 for more information.

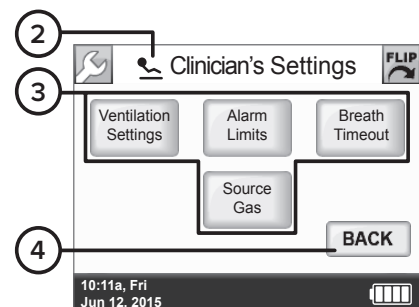
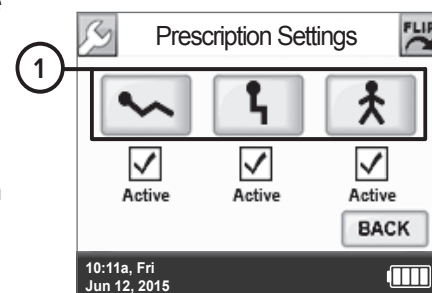

Activating prescription settings

- 1 Each icon on the **Prescription Settings** screen represents a prescription.

Check the box below a **Prescription Setting** button to make the prescription active (checked) or inactive (unchecked) for patient selection. Only Active (checked) **Prescription Setting** buttons are available to the patient as therapy options.

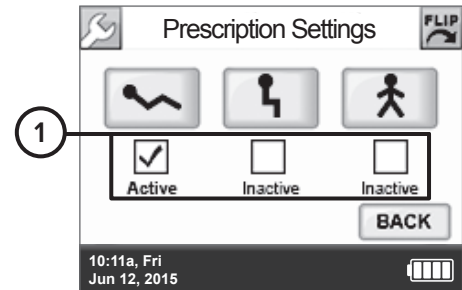

NOTE

At least one **Prescription Setting** must always be checked (**Active**).

- 2 Activating (checking) a **Prescription Setting** button makes that Activity Button available to the patient for selection on the ventilator.

In the example below, the **Low Activity Prescription Setting** is activated for patient selection on the ventilator using the Low Activity button.

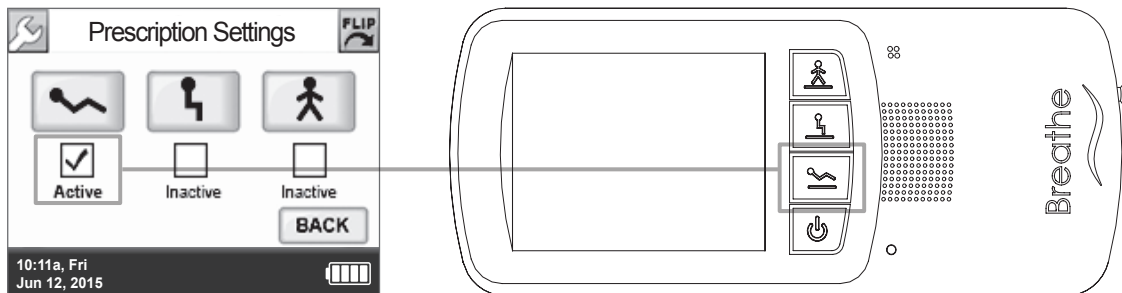



*Ventilators may not be configured with the Battery Charger Dongle.

NOTE

Making a **Prescription Setting** button active (checked) does not begin ventilation therapy; an Activity button must also be selected on the ventilator. For more information, see "Choosing an activity button (Patient selectable) to begin ventilation" on page 65.

Factory default prescription settings

The following table lists the Life2000® factory default prescription settings that may be edited. For a full list of factory defaults, see the "Summary of factory default settings" on page 75.

DESCRIPTION	DEFAULT VALUE		
	 LOW ACTIVITY	 MEDIUM ACTIVITY	 HIGH ACTIVITY
Ventilation Settings			
Volume	150 ml	180 ml	200 ml
I-Time (Inspiratory Time)	0.75 sec		
PEEP (Positive End Expiratory Pressure)	0 cmH ₂ O		
Sensitivity (Trigger Sensitivity)	4*		
BR (Breath Rate)	12 BPM*		
* Ventilation mode: Assist/Control ventilation mode			
Alarm Limits			
High BR (Breath Rate) alarm limit	50 BPM		
Low BR (Breath Rate) alarm limit	5 BPM		
High PIP (Peak Inspiratory Pressure) alarm limit	30 cmH ₂ O		
Low PIP (Peak Inspiratory Pressure) alarm limit	1 cmH ₂ O		
Breath Timeout			
Breath Timeout Period	60 seconds		
Breath Timeout Action	12 BPM		
Source Gas			
Source Gas	Air		

NOTE

Each prescription setting is independent of other prescription settings.

The following factory default cannot be edited:

DESCRIPTION	DEFAULT VALUE
High PEEP (Positive End Expiratory Pressure) alarm limit	+7 cmH ₂ O (above PEEP setting)

Breath types

There are two breath types that apply to the Volume Control ventilation provided by the ventilation system:

- Mandatory
- Assisted

Mandatory breath

A mandatory breath (or machine breath) is completely controlled by the ventilation system. The system controls both the beginning (triggering) and end (cycling) of the inspiratory phase.

Assisted breath

An assisted breath is controlled by both the patient and the ventilation system. Breaths are initiated by the patient's effort and volume delivery is controlled by the prescribed volume setting and inspiratory time.

Ventilation modes

The ventilation system delivers an inspired tidal volume to the patient according to the clinical settings: volume, breath rate, trigger sensitivity, PEEP, and inspiratory time. Three different volume control modes are available:

- Control
- Assist/Control
- Assist

Ventilation settings and modes

The **Ventilation Settings** screen provides options to set different ventilation modes. Consult the following table to adjust parameters accordingly:

VENTILATION MODES*	SET TRIGGER SENSITIVITY TO:	SET BREATH RATE TO:
Control	OFF	≥ 1
Assist/Control	0 to 9	≥ 1
Assist	0 to 9	0

* Settings based on prescription

Setting ventilation parameters in control ventilation mode

In this mode, the ventilation system delivers volume control therapy only for mandatory breaths. A mandatory breath is delivered according to the breath setting (BPM). This also means that a breath will not be triggered based on patient's inspiratory effort.

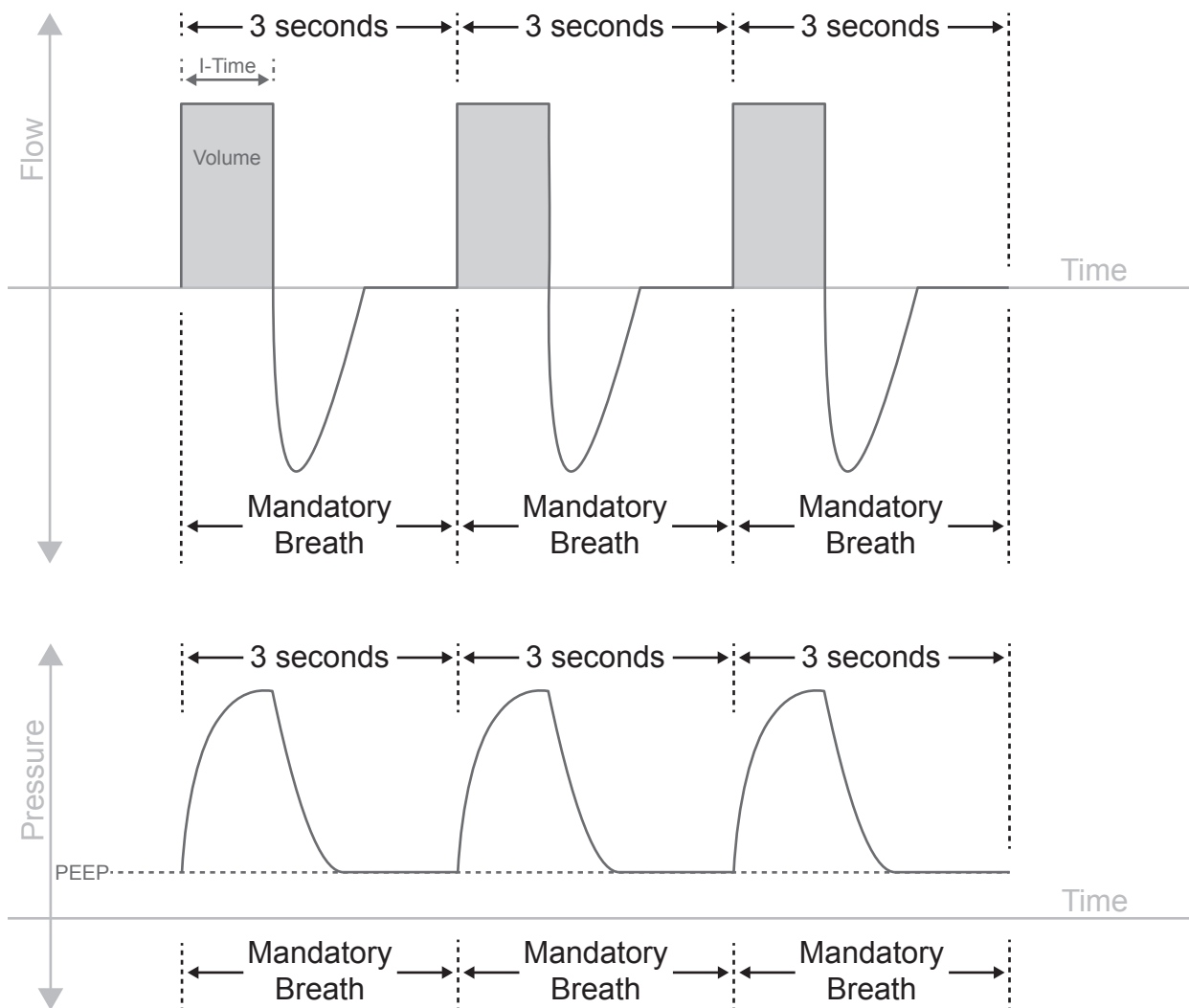

To set a prescription setting for Control Ventilation Mode, the following parameters need to be set according to the table below:

VENTILATION MODE*	SET TRIGGER SENSITIVITY TO:	SET BREATH RATE TO:
Control	OFF	≥ 1
* Settings based on prescription		

To set the prescription setting:

- 1 On the **Clinician's Settings** screen, touch **Ventilation Settings**.
- 2 On the **Ventilation Settings** screen, touch the box beside the setting you want to change.
- 3 Touch the **Up** arrow to increase the value in the box or the **Down** arrow to decrease it.
Pressing and holding an arrow button will continue to increase or decrease the value.
- 4 Repeat steps 2 and 3 for each setting you want to change, and then touch **OK**.
- 5 In the message asking if the settings are **OK**, touch **CONFIRM**.

NOTE

Changes to settings only take effect when you touch **CONFIRM**.

NOTE

An "Incompatible Settings" message appears when the PEEP or Volume setting is incompatible to maintain clinical settings. Touch **OK** and then re-evaluate and readjust the Volume, PEEP, or I-Time setting in the **Ventilation Settings** screen. For more information, see "Incompatible Settings" message" on page 66.

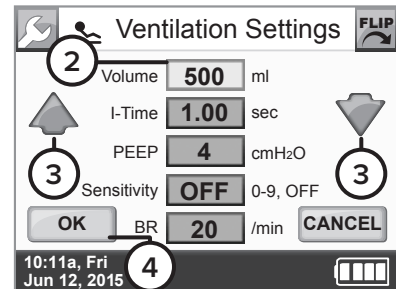
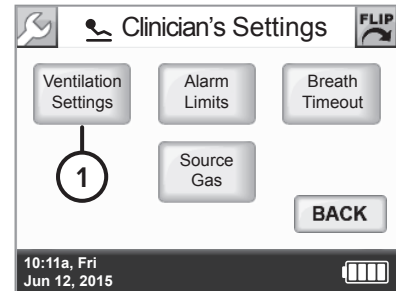

Values displayed on the screen are for illustrative purposes only.

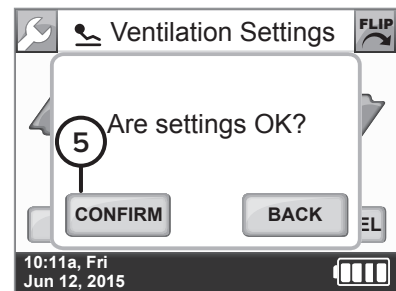

Setting ventilation parameters in assist/control ventilation mode

In this mode, the ventilation system provides Tidal Volume during inhalation for assisted and mandatory breaths. An assisted breath is started when there is patient effort, but it is ended when the Inspiratory Time setting has been met. A mandatory breath is delivered if the patient does not breathe within the prescribed Breath Rate setting. This ensures that the patient receives a minimum number of breaths per minute.

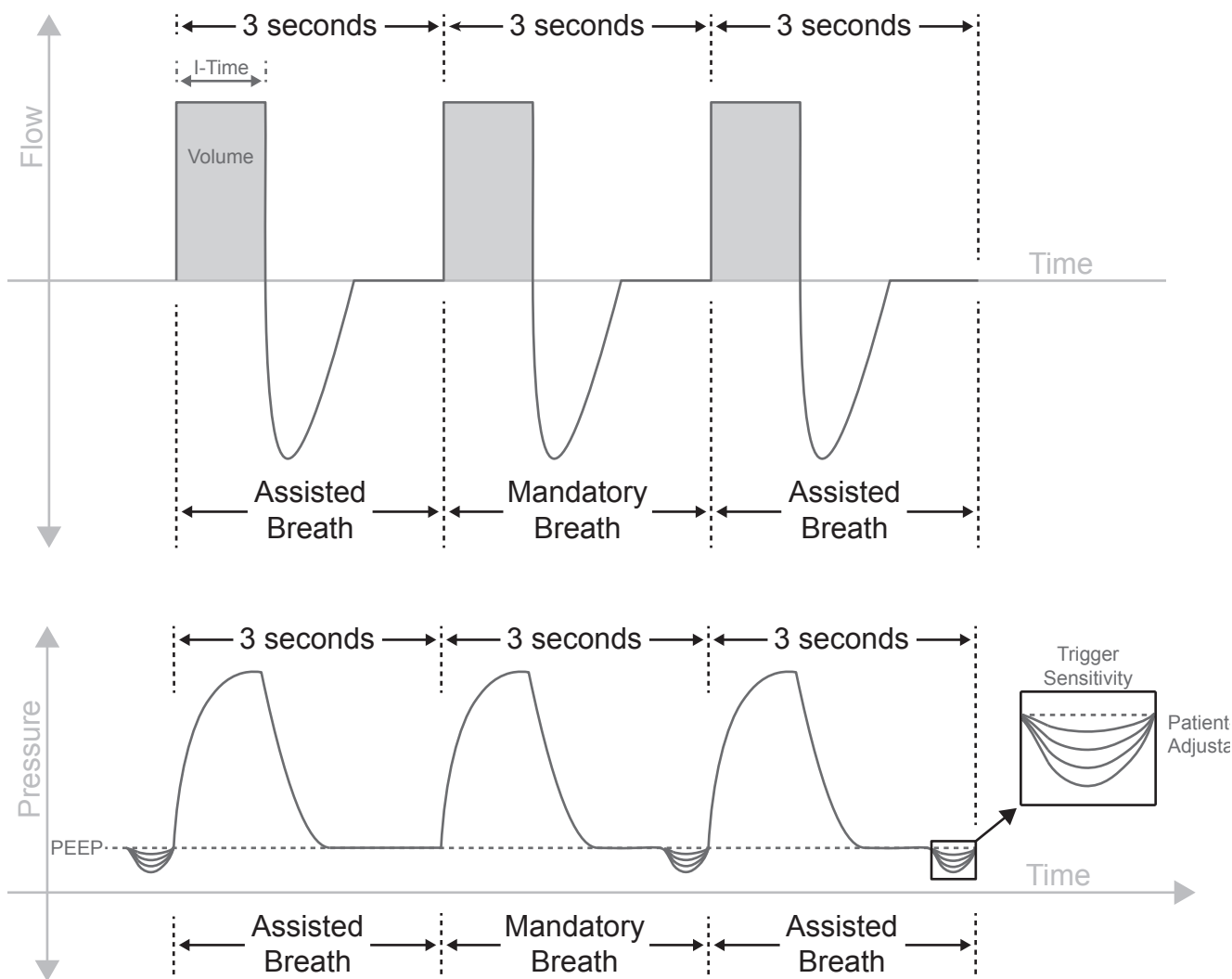

To set a prescription setting for Assist/Control ventilation mode, the following parameters need to be set according to the table below:

VENTILATION MODE*	SET TRIGGER SENSITIVITY TO:	SET BREATH RATE TO:
Assist/Control	0 to 9	≥ 1
* Settings based on prescription		

To set the prescription setting:

- 1 On the **Clinician's Settings** screen, touch **Ventilation Settings**.
- 2 On the **Ventilation Settings** screen, touch the box beside the setting you want to change.
- 3 Touch the **Up** arrow to increase the value in the box or the **Down** arrow to decrease it.
Pressing and holding an arrow button will continue to increase or decrease the value.
- 4 Repeat steps 2 and 3 for each setting you want to change, and then touch **OK**.
- 5 In the message asking if the settings are OK, touch **CONFIRM**.

NOTE

Changes to settings only take effect when you touch **CONFIRM**.

NOTE

An "Incompatible Settings" message appears when the PEEP or Volume setting is incompatible to maintain clinical settings. Touch **OK** and then re-evaluate and readjust the Volume, PEEP, or I-Time setting in the **Ventilation Settings** screen. For more information, see "Incompatible Settings" message" on page 66.

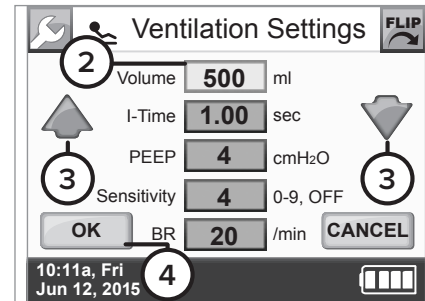
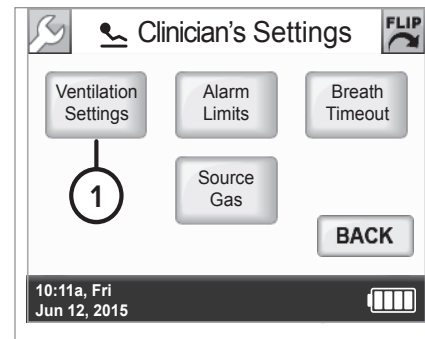

Values displayed on the screen are for illustrative purposes only.

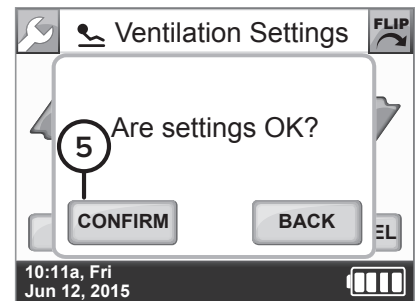

Setting ventilation parameters in assist ventilation mode

In this mode, the ventilation system provides Tidal Volume during inhalation for assisted breaths. An assisted breath is started when there is patient effort and is ended when the Inspiratory Time setting has been met. If the ventilation system does not detect breaths during the allotted time as defined by the “Breath Timeout parameter,” the ventilation system will deliver breaths or a continuous flow of gas based on the “Timeout Action” parameter setting.

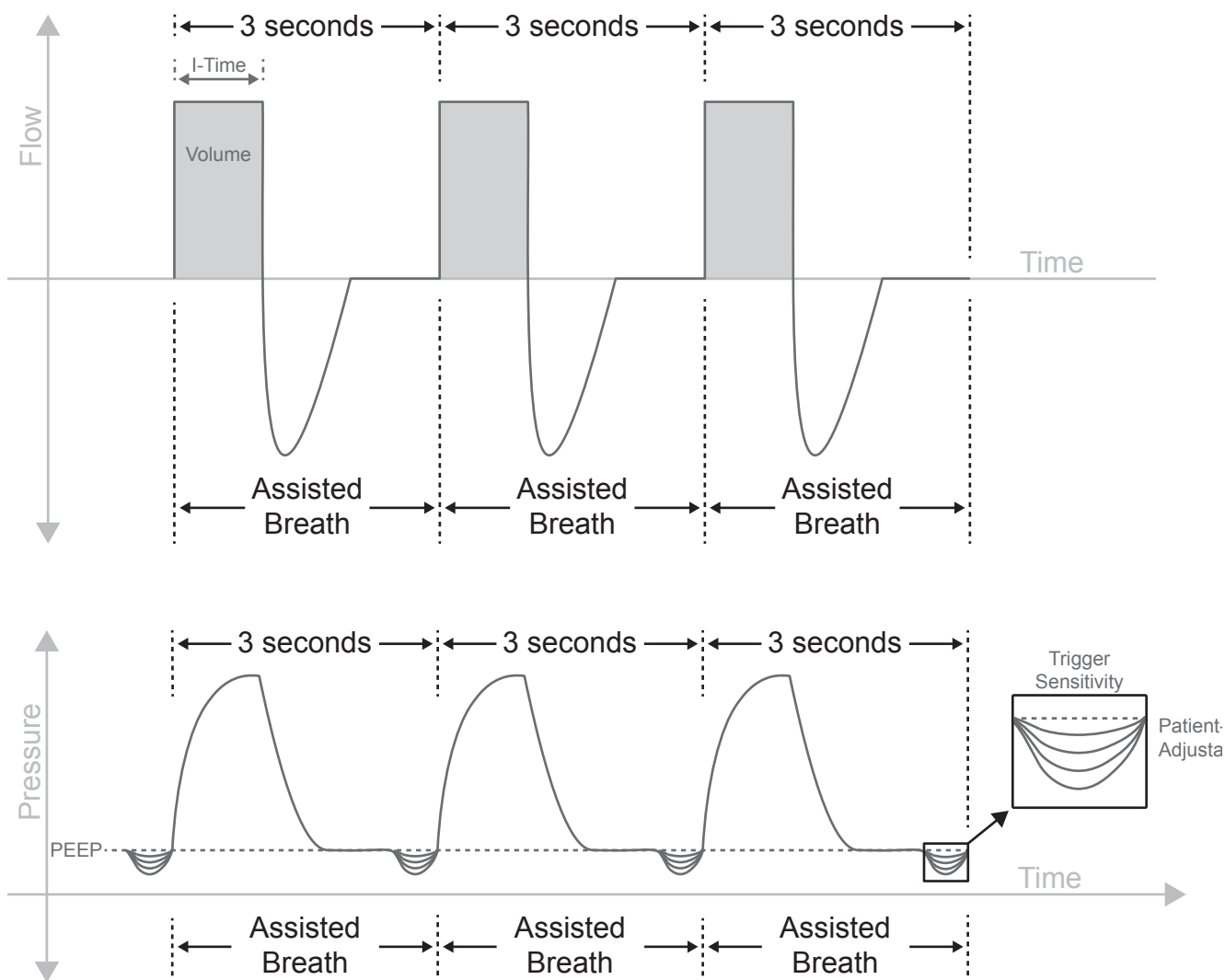

To set a prescription setting for Assist Ventilation Mode, the following parameters need to be set according to the table below:

VENTILATION MODE	SET TRIGGER SENSITIVITY TO:	SET BREATH RATE TO:
Assist	0 to 9	0
* Settings based on prescription		

To set the prescription setting:

1 On the **Clinician's Settings** screen, touch **Ventilation Settings**.

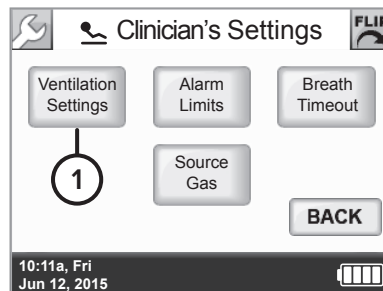

2 On the **Ventilation Settings** screen, touch the box beside the setting you want to change.

3 Touch the **Up** arrow to increase the value in the box or the **Down** arrow to decrease it.

Pressing and holding an arrow button will continue to increase or decrease the value.

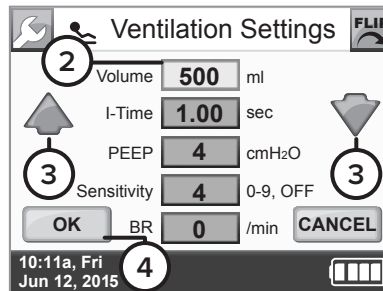

Values displayed on the screen are for illustrative purposes only.

4 Repeat steps 2 and 3 for each setting you want to change, and then touch **OK**.

5 In the message asking if the settings are OK, touch **CONFIRM**.

NOTE

Changes to settings only take effect when you touch **CONFIRM**.

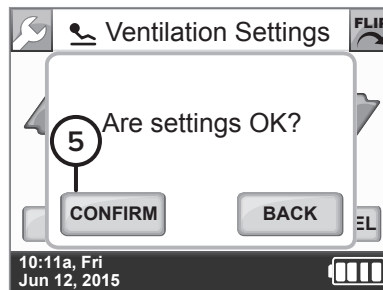

NOTE

An "Incompatible Settings" message appears when the PEEP or Volume setting is incompatible to maintain clinical settings. Touch **OK** and then re-evaluate and readjust the Volume, PEEP, or I-Time setting in the **Ventilation Settings** screen. For more information, see "Incompatible Settings" message" on page 66.

Ventilation settings summary

PARAMETER	MINIMUM	MAXIMUM	INCREMENT
Volume (ml)	50	750	10
I-Time (sec)	0.15	3.00	0.05
PEEP (cmH ₂ O)	0	10 or 20*	1
Sensitivity	Control ventilation mode: OFF	Control ventilation mode: OFF	1
	Assist or Assist/Control ventilation mode: 9	Assist or Assist/Control ventilation mode: 0	
BR (/min)	0	40	1

*For software revisions before 06.08.00.00, PEEP Range is 0 to 10 cmH₂O.



TIPS

- **Volume:** You can set an output volume between 50 ml and 750 ml, in increments of 10 ml.

The ventilator set volume does not correspond to total delivered volume of gas delivered to the lung i.e. tidal volume. Total delivered volume will include ventilator set volume, entrained air, and supplemental oxygen (if applicable), and therefore will be higher than the ventilator set volume. For more information see "Potential Tidal Volumes" on page 159.



NOTE

Volume levels are not adjusted for altitude. For more information see the "Appendix" on page 155.

- **I-Time (Inspiratory Time):** The time over which the selected target volume is delivered.



NOTE

The actual I-Time may be longer or shorter than set if additional time is required to deliver the set volume. The actual delivery time may also be longer or shorter than set to maintain a minimum delivered peak gas flow rate of 8–40 LPM range.

- **PEEP (Positive End Expiratory Pressure):** PEEP can be adjusted as per the prescription. PEEP values can be set from 0–10 cm H₂O (for software versions before 06.08.00.00) or 0–20 cm H₂O (for software versions 06.08.00.00 or newer).



WARNINGS

- If upgrading software from version 05.11.00 to 05.12.00 re-evaluate the ventilator settings if PEEP is applied.
- If upgrading a patient ventilator from ventilator REF MS-01-0001 to ventilator REF MS-01-0118 re-evaluate ventilator settings if PEEP is applied.

- **Sensitivity (Trigger Sensitivity):** Specifies the minimum negative pressure threshold necessary to trigger a delivery. The sensitivity setting, adjustable in increments of 1, ranges from 0–9 or OFF, with 0 being the most sensitive and 9 being the least sensitive.



NOTES

- Trigger sensitivity can be adjusted by the patient unless it is set to **OFF** in the **Ventilation Settings** screen. For more information, see "Adjusting the trigger sensitivity (Patient adjustable)" on page 67.
- Trigger sensitivity settings vary in a non-linear fashion, with relatively finer resolution at lower settings and relatively coarser resolution at higher settings.
- Trigger sensitivity can be adjusted by both the clinician and the patient. Breaths can be triggered by the patient or by the ventilator based on the **Ventilation Settings**.

- **BR (Breath Rate):** The breath rate per minute determines the minimum quantity of machine breaths delivered.

Setting alarm limits for breath rate and PIP

To view or edit critical alarms, access the **Alarm Limits** screen from the **Clinician's Settings** screen.

- 1 On the **Clinician's Settings** screen, touch **Alarm Limits**.

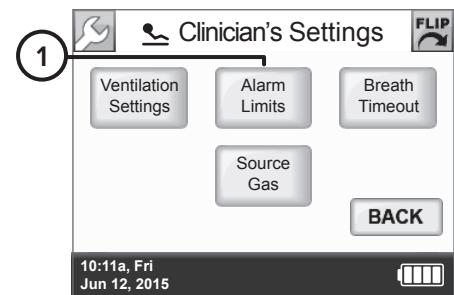

- 2 On the **Set Alarm Limits** screen, touch the box corresponding to the alarm limit you want to change.

- 3 Touch the **Up** arrow or the **Down** arrow to change the value in the box. Pressing and holding an arrow button will continue to increase or decrease the value.

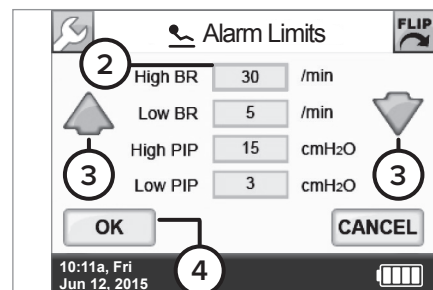

Values displayed on the screen are for illustrative purposes only.

- 4 Repeat steps 2 and 3 for each setting you want to change, and then touch **OK**.

- 5 In the message asking if the settings are OK, touch **CONFIRM**.

NOTE

Changes to settings only take effect when you touch **CONFIRM**.

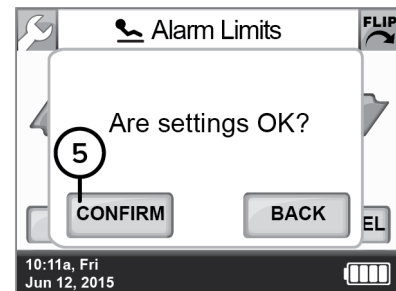

Alarm limits settings summary

ALARM	DEFAULT	MINIMUM	MAXIMUM	INCREMENT
High Breath Rate Alarm Limit (BPM)	50	5	120	1
Low Breath Rate Alarm Limit (BPM)	5	0	119	1
High PIP Alarm Limit (cmH ₂ O)	30	5	40	1
Low PIP Alarm Limit (cmH ₂ O)	1	1	15	1

TIP

The breath rate monitor value is based on a four-breath average.

Setting breath timeout (Apnea backup ventilation mode)

- 1 On the **Clinician's Settings** screen, touch **Breath Timeout**.

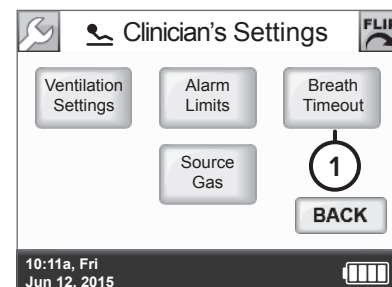

- 2 On the **Breath Timeout** screen, touch the **Timeout Period** or **Timeout Action** box you want to change.

i TIP

The **Breath Timeout** screen has two options for setting the **Breath Timeout** alarm. You can set the time to trigger the alarm at 20 or 60 seconds and the backup ventilation mode to 3 LPM continuous flow or 12 BPM at the current volume setting.

- 3 Touch the **Up** arrow or the **Down** arrow to change the value in the box. Pressing and holding an arrow button will continue to increase or decrease the value.

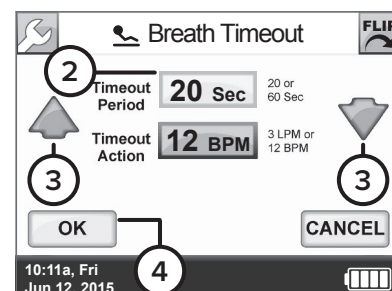

Values displayed on the screen are for illustrative purposes only.

- 4 Repeat steps 2 and 3 for each setting you want to change, and then touch **OK**.

- 5 In the message asking if the settings are OK, touch **CONFIRM**.

NOTE

Changes to settings only take effect when you touch **CONFIRM**.

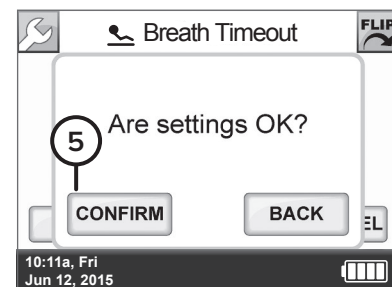

Breath timeout settings summary

PARAMETER	DEFAULT	ALTERNATE
Timeout Period	60 seconds	20 seconds
Timeout Action	12 BPM	3 LPM

Selecting the source gas

The Life2000® Ventilation System uses **Air** as the factory set default source gas. If using an oxygen cylinder, select **O₂** as the **Source Gas**.

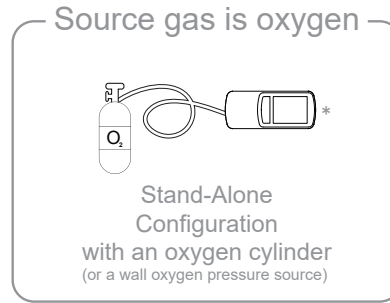
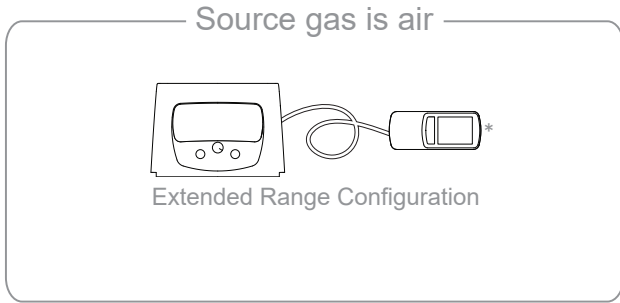

*Ventilators may not be configured with the Battery Charger Dongle.

- 1 On the **Clinician's Settings** screen, touch **Source Gas**.

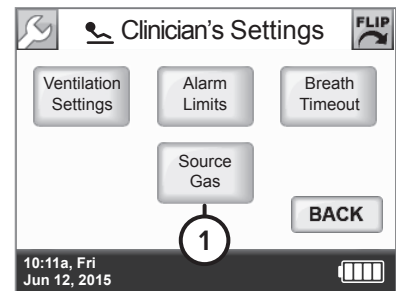

- 2 On the **Source Gas** screen, touch the appropriate check box for the source gas prescribed by the physician.

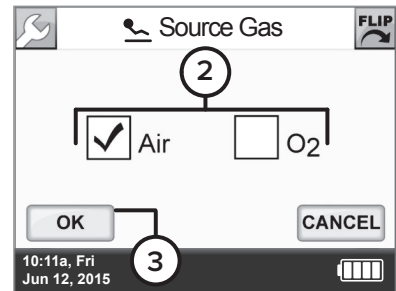

- 3 Touch **OK** to confirm your selection.

- 4 In the message asking if the settings are OK, touch **CONFIRM**.

NOTE

Changes to settings only take effect when you touch **CONFIRM**.

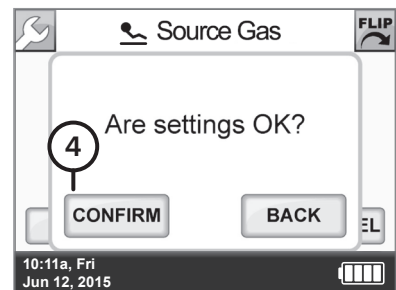

Source gas settings summary

DEFAULT	ALTERNATE
Air	O ₂ (Oxygen)

Choosing an activity button (Patient selectable) to begin ventilation

When the ventilator is first powered on, you must select an Activity button to begin ventilation. The three Activity buttons on the ventilator are programmed to correspond to up to three different prescriptions as directed by a physician.

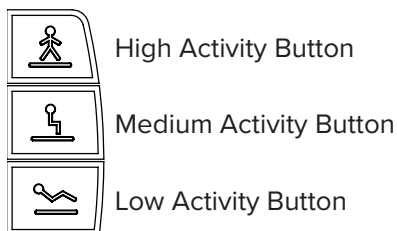

Choose an Activity button appropriate for the patient's needs. The selection can be changed by the patient at any time, if set and activated by a clinician.

NOTE

One, two, or three Activity Buttons may be available, as directed by a physician. For more information, see "Prescription settings" on page 51.

- 1 Ensure that the ventilator is powered on.
- 2 Ensure a pressure source (the compressor, an oxygen cylinder, or an oxygen wall source) is connected to the ventilator and turned on.
- 3 Press and hold an Activity button until you hear a tone that indicates it is active. The touch screen will display the **Home** screen and the ventilator will begin delivering therapy.

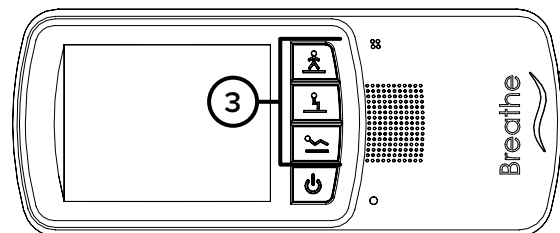

*Ventilators may not be configured with the Battery Charger Dongle.

- 4 Confirm the selected **Activity** icon is displayed at the bottom of the touch screen and the icon and volume are displayed at the top of the screen. (The **High Activity** icon is shown for illustrative purposes here.) The ventilator will begin ventilating using the chosen prescription parameters for the next breath.

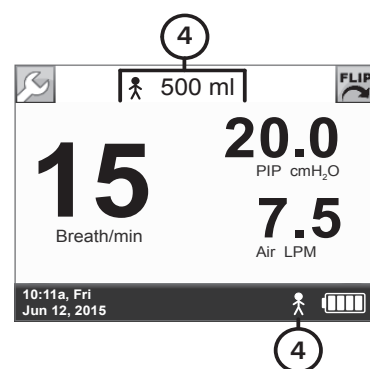

Values displayed on the screen are for illustrative purposes only.

NOTE

The currently-ventilating **Activity** icon and volume are displayed at the top of all screens unless you are in the Clinician's menu.

“Incompatible Settings” message

If the selected Activity Button represents a prescription that is not available, this message will appear on the touch screen. If therapy had already started with a different Activity Button, the ventilator will continue delivering therapy using the prescription represented by the previous Activity Button.

Touch **OK** and choose another active Activity Button to change the currently-ventilating prescription.

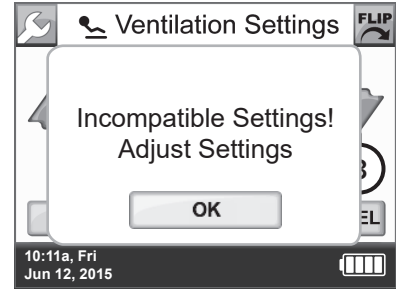

“This Prescription Setting is not active” message

If the selected Activity button represents a prescription that is not available, this message will appear on the touch screen. If therapy had already started with a different Activity button, the ventilator will continue delivering therapy using the prescription represented by the previous Activity button.

Touch **OK** and choose another active Activity Button to change the currently-ventilating prescription.

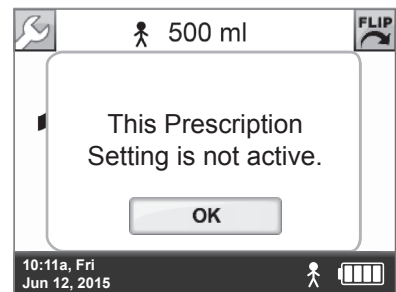

Values displayed on the screen are for illustrative purposes only.

“Connect Oxygen source” or “Disconnect Oxygen source” message

After powering on, or during therapy when selecting an Activity Button with a different source gas, a message will appear as a reminder to connect or disconnect oxygen as appropriate.

After connecting or disconnecting oxygen, touch **OK** to begin ventilating using the prescription represented by the new Activity button.

For more information, see "Selecting the source gas" on page 64.

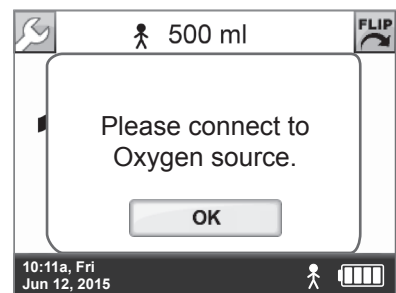

Values displayed on the screen are for illustrative purposes only.

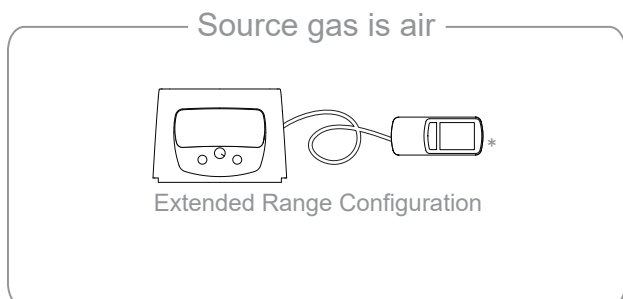

*Ventilators may not be configured with the Battery Charger Dongle.

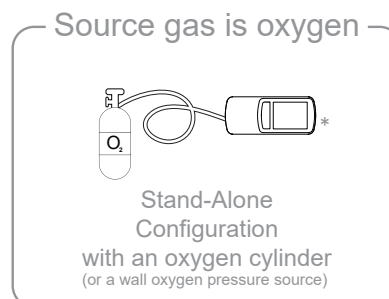

Adjusting the trigger sensitivity (Patient adjustable)

Trigger sensitivity determines how easily a patient's inspiratory effort triggers the breath delivery. For shallow breathing, set the trigger sensitivity to a low number. You can choose a setting between 0 and 9. Zero is the most sensitive and 9 is the least sensitive setting.

An Activity button must already be selected (the ventilator must be currently ventilating) to allow changes to the Trigger Sensitivity settings through the patient-accessible **Settings** menu.

NOTE

Trigger Sensitivity cannot be adjusted by patients when the currently-ventilating Activity Button represents a prescription in Control Mode (Sensitivity is OFF).

Accessing the trigger sensitivity screen

① On any screen, touch the **Wrench**.

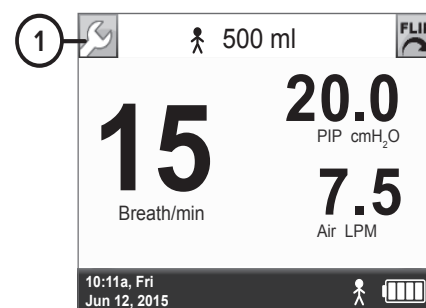

Values displayed on the screen are for illustrative purposes only.

② On the **Menu** screen, touch **Settings**.

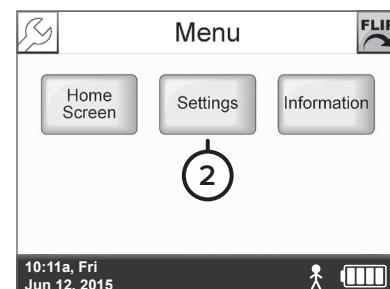

③ On the **Settings** menu screen, touch **Trigger Sensitivity**.

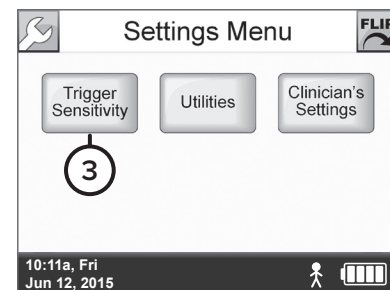

NOTES

A grayed-out Trigger Sensitivity button indicates that this feature is not available for one of the following reasons:

- An Activity button has not been chosen (the ventilator is not currently ventilating). For more information, see "Choosing an activity button (Patient selectable) to begin ventilation" on page 65.
- The currently-ventilating Activity Button represents a prescription in Control Mode. For more information, see "Setting ventilation parameters in control ventilation mode" on page 55.

Changing trigger sensitivity

- 1 While ventilating, on the **Trigger Sensitivity** screen, touch the **Up** arrow to increase the value or the **Down** arrow to decrease it. Holding down an arrow button will continue to increase or decrease the value.

 **NOTE**

The lower the number, the more sensitive the setting.

- 2 When you are finished, touch **OK**.

- 3 In the message asking if the settings are OK, touch **CONFIRM**.

 **NOTE**

Changes to settings only take effect when you touch **CONFIRM**.

This **Trigger Sensitivity** setting will be saved as part of the currently-ventilating prescription.

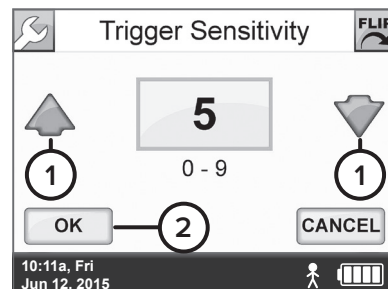

Values displayed on the screen are for illustrative purposes only.

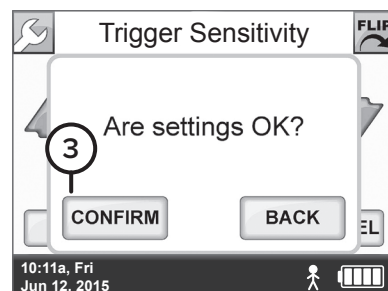

Accessing the utilities menu

Within the **Utilities** menu, you can change the time and date, brightness of the touch screen, volume of audible alarms, and set alarms to vibrate mode.

① On any screen, touch the **Wrench** button.

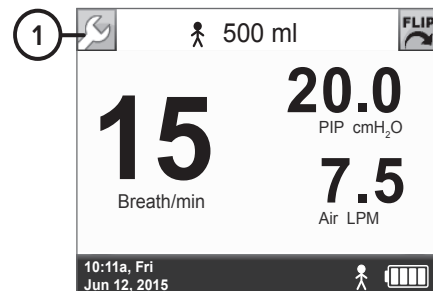

Values displayed on the screen are for illustrative purposes only.

② On the **Menu** screen, touch **Settings**.

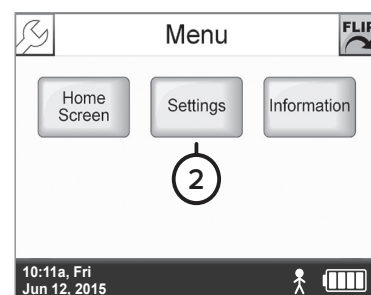

③ On the **Settings** menu screen, touch **Utilities**.

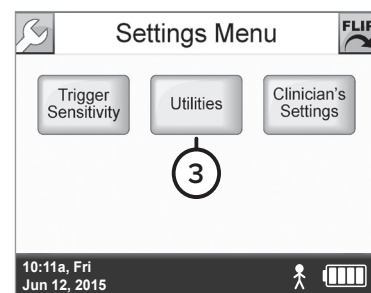

Setting time and date

- 1 On the **Utilities** menu screen, touch **Set Time/Date**.

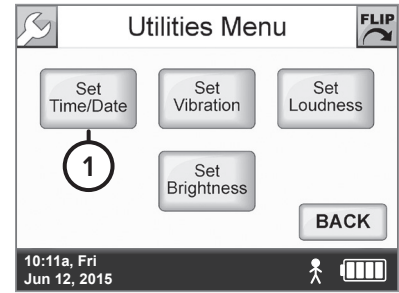

- 2 On the **Set Time/Date** screen, touch the box you want to change.

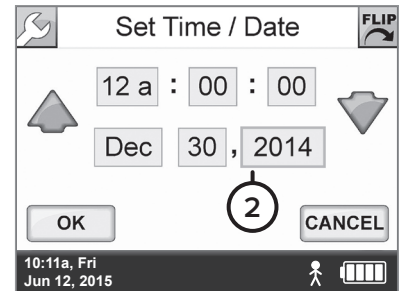

Values displayed on the screen are for illustrative purposes only.

- 3 Touch the **Up** arrow to increase the value in the box or the **Down** arrow to decrease it.

Pressing and holding an arrow button will continue to increase or decrease the value.

- 4 Repeat steps 2 and 3 for each box you want to change, and then touch **OK**.

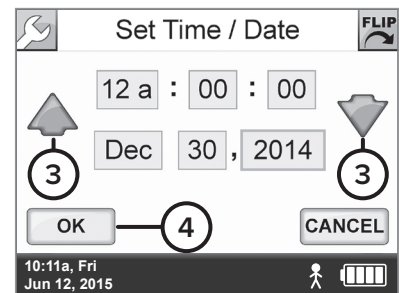

Values displayed on the screen are for illustrative purposes only.

- 5 In the message asking if the settings are **OK**, touch **CONFIRM**.

NOTE

Changes to settings only take effect when you touch **CONFIRM**.

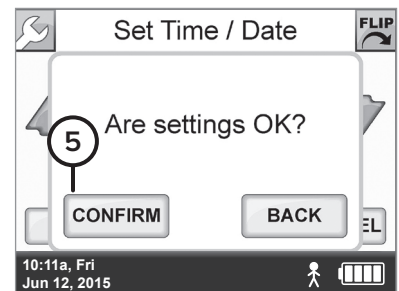

Setting vibration mode

The **Set Vibration** screen lets you change alarm notifications from audible tones to a vibration. However, if a low- or medium-priority vibrating alarm occurs and is not resolved in 60 seconds, an audible alarm occurs. For a high-priority alarm, an audible tone immediately occurs with a vibration alarm with no delay.

- 1 On the **Utilities Menu** screen, touch **Set Vibration**.

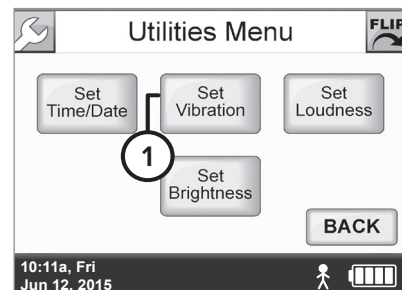

- 2 On the **Set Vibration** screen, touch **ON** or **OFF**.

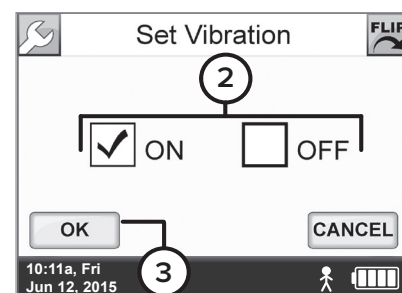

- 3 When you are finished, touch **OK**.

- 4 In the message asking if the settings are OK, touch **CONFIRM**.

NOTE

Changes to settings only take effect when you touch **CONFIRM**.

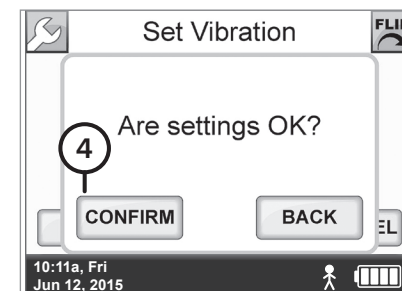

- 5 Check that the **Vibrate** icon  appears, indicating the ventilator is in vibrate mode.

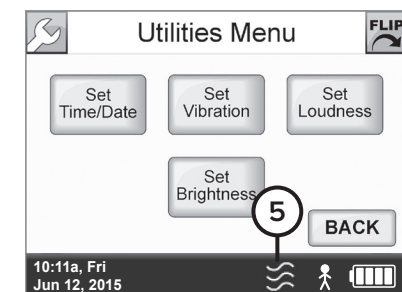

Vibration settings summary

DEFAULT	ALTERNATE
OFF	ON

Setting audio loudness

WARNING

Ensure that the alarm loudness is set above the loudness of your surroundings.

① On the **Utilities Menu** screen, touch **Set Loudness**.

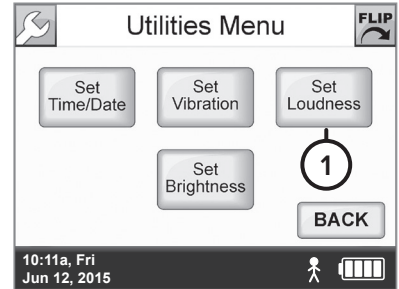

② Touch the **Up** arrow to increase the audio loudness level or the **Down** arrow to decrease it.

Pressing and holding an arrow button will continue to increase or decrease the value.

You can choose a loudness level between 1 and 5, with 5 being the loudest and 1 the quietest.

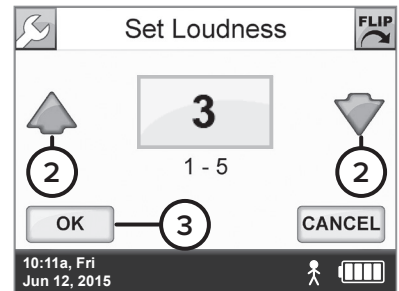

Values displayed on the screen are for illustrative purposes only.

③ When you are finished, touch **OK**.

④ In the message asking if the settings are OK, touch **CONFIRM**.

NOTE

Changes to settings only take effect when you touch **CONFIRM**.

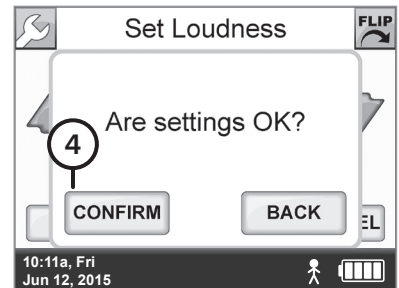

Loudness settings summary

DEFAULT	MINIMUM	MAXIMUM	INCREMENT
5	1	5	1

Adjusting screen brightness

1 On the **Utilities Menu** screen, touch **Set Brightness**.

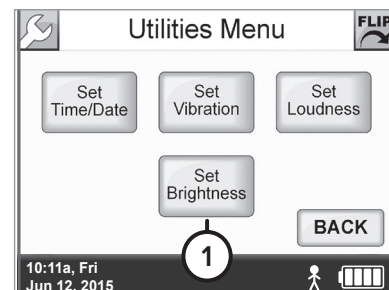

2 Touch the **Up** arrow to increase the brightness or the **Down** arrow to decrease it.

Pressing and holding an arrow button will continue to increase or decrease the value.

You can choose a brightness level between 1 and 5, with 5 being the brightest and 1 the dimmest.

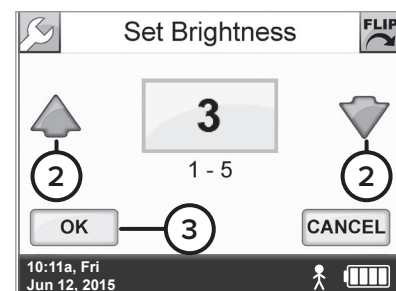

Values displayed on the screen are for illustrative purposes only.

3 When you are finished, touch **OK**.

4 In the message asking if the settings are OK, touch **CONFIRM**.

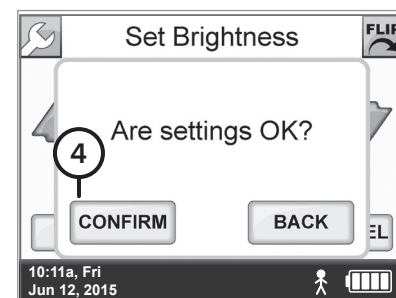

Brightness settings summary

DEFAULT	MINIMUM	MAXIMUM	INCREMENT
3	1	5	1

Viewing software version information

The Information screen displays information about the ventilator and its operation.

① On any screen, touch the **Wrench**.

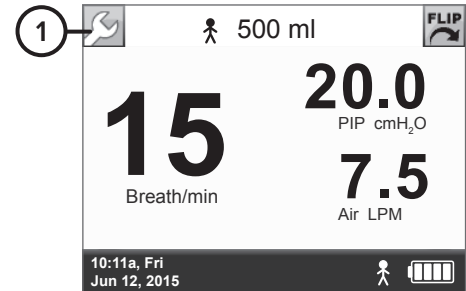

Values displayed on the screen are for illustrative purposes only.

② On the **Menu** screen, touch **Information**.

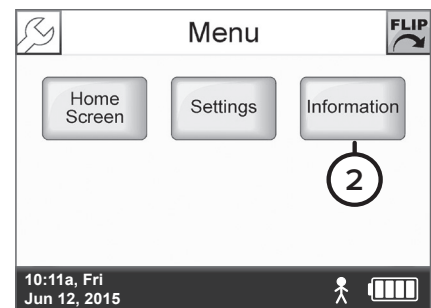

③ The screen displays information about the ventilator and its operation.

- Software Version is the version of software currently running on the ventilator.
- Serial Number is the ventilator's serial number.
- Operating Time is the total time the ventilator has been powered on.
- High Activity Time is the time the ventilator has delivered therapy using the High Activity prescription.
- Medium Activity Time is the time the ventilator has delivered therapy using the Medium Activity prescription.
- Low Activity Time is the time the ventilator has delivered therapy using the Low Activity prescription.
- Total Activity Time is the total time the ventilator has delivered therapy using any of the three prescriptions (Total Activity Time = High Activity Time + Medium Activity Time + Low Activity Time).

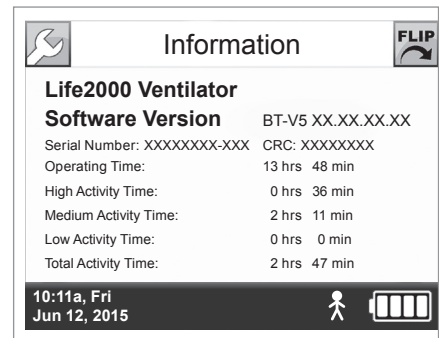



Values displayed on the screen are for illustrative purposes only.

These screen values are accurate to within two minutes.

Summary of factory default settings

The following table lists the factory default settings for the ventilator.

CLINICIAN'S MENU SETTINGS	DEFAULT VALUE		
	 LOW ACTIVITY	 MEDIUM ACTIVITY	 HIGH ACTIVITY
Ventilation Settings			
Volume	150 ml	180 ml	200 ml
I-Time (Inspiratory Time)	0.75 sec		
PEEP (Positive End Expiratory Pressure)	0 cmH ₂ O		
Sensitivity (Trigger Sensitivity)	4*		
BR (Breath Rate)	12 BPM*		
* Ventilation mode: Assist/Control ventilation mode			
Alarm Limits			
High BR (Breath Rate) alarm limit	50 BPM		
Low BR (Breath Rate) alarm limit	5 BPM		
High PIP (Peak Inspiratory Pressure) alarm limit	20 cmH ₂ O		
Low PIP (Peak Inspiratory Pressure) alarm limit	1 cmH ₂ O		
High PEEP (Positive End Expiratory Pressure) Pressure alarm limit	+7 cmH ₂ O (above PEEP setting) [†]		
[†] High PEEP Pressure alarm limit is automatically set and cannot be adjusted.			
Breath Timeout			
Breath Timeout Period	60 seconds		
Breath Timeout Action	12 BPM		
Source Gas			
Source Gas	Air		
UTILITIES MENU SETTINGS		DEFAULT VALUE	
Vibration	OFF		
Audio Loudness	5		
Screen Brightness	3		

NOTE

Default values may be reset by entering the above values into the ventilator.

Alarms, alerts, and troubleshooting

Introduction to alarms and alerts



WARNINGS

- If the Life2000® Ventilation System is not functioning properly, patient may not received adequate respiratory therapy and may result in patient harm or death. Always have an alternate means of ventilation or oxygen therapy available.
- Ensure that the alarm loudness is set above the loudness of your surroundings.
- Do not cover the ventilator, touch screen, speaker, or backup alarm buzzer with tape or any other object. Covering the ventilator or any of its parts might cause difficulty in hearing alarms and might affect ventilator performance.
- Do not cover or block the compressor's internal alarm buzzer with any object. Covering the buzzer may make it difficult for a patient or caregiver to hear alarms, which may result in inadequate respiratory therapy.

There are two types of notifications provided by the Life2000® Ventilation System:

Ventilator alarms

Ventilator alarms are visual notifications that appear on the touch screen and are accompanied by distinct sounds or vibration (when set to vibrate).

Compressor alerts

The compressor has audible alerts that are independent of the ventilator. Compressor alerts must be resolved for the compressor alert notifications to be silenced as there is no button to silence alerts originating from the compressor.

Ventilator on-screen alarm sounds and message display

When an alarm notification occurs there is a distinct sound and a display message corresponding to the priority level of the alarm. The priority level of an alarm is indicated by the color and the rate at which the message flashes.



High-Priority Alarm

A red, rapidly flashing alarm message indicates a situation that requires immediate attention.

Sound: Sequence of two sets of five tones



Medium-Priority Alarm

A yellow, steadily flashing alarm message indicates a potentially hazardous situation that must be resolved in a timely manner.

Sound: Sequence of three tones



Low-Priority Alarm

A blue, non-flashing alarm message indicates a problem that is not hazardous but should be resolved.

Sound: Single tone

Active Alarms Window

Multiple on-screen alarms may occur at the same time. Touch the **Active Alarms** button at the top of the touch screen to display a list of active on-screen alarms.



The **Active Alarms** button is only visible during ventilator on-screen alarm notifications.



The **Active Alarms** window displays up to three on-screen alarms, from highest to lowest priority (red, yellow, blue). If there are more than three alarms, you can use the **Scroll Up** and **Scroll Down** arrows to scroll through the list.

- 1 Touch the **Active Alarms** button to display the alarm list.
- 2 Alarm icon
- 3 Use the **Scroll Down Arrow** to view additional active alarms.
- 4 Use the **Scroll Up Arrow** to go to the beginning of the list of active alarms.
- 5 Alarm message alternates between each occurring alarm.
- 6 Alarm Silenced icon.
- 7 Alarm Silenced icon is displayed at the bottom of the touch screen when all alarms are silenced.

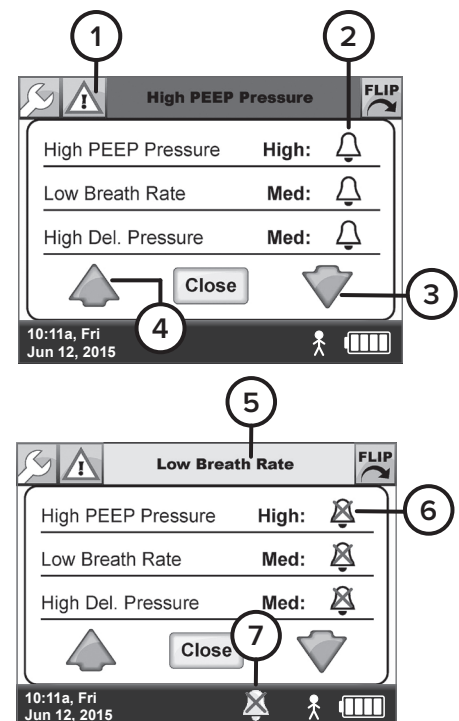

Silencing and Clearing On-Screen Alarms

Alarm notifications that appear on the touch screen originate from the ventilator. Silencing and clearing on-screen alarms is a multi-step process that depends on alarm priority and how many alarms are active.

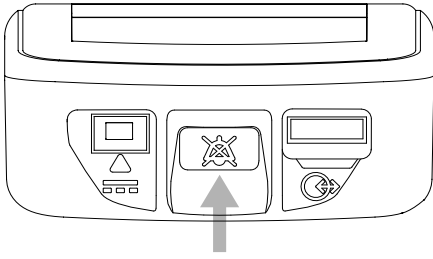

Silence Alarm button on ventilator (when in Extended Range or Stand-Alone Configuration).

- 1 Press the Silence Alarm button to temporarily silence the on-screen alarm for 60 seconds. Pressing the Silence Alarm button silences only one alarm at a time—in audible or vibrating alarm mode. If more than one on-screen alarm occurs, press the Silence Alarm button once for each alarm.

If the on-screen alarm is a medium- or high-priority alarm and is not silenced after 60 seconds, the alarm will continue with an additional buzzer and the breath light indicator will illuminate red until the condition is resolved.

- 2 Resolve the condition that triggered the on-screen alarm. For help resolving alarms, see the alarm tables that follow for possible causes of an alarm and options to resolve it. If a Silence Alarm button is pressed but the condition that triggered the alarm is not resolved, the alarm will sound again after 60 seconds.
- 3 After resolving a High Temperature, High Circuit Pressure, or High PEEP Pressure high-priority alarm, touch **OK** in the message that indicates the alarm has been resolved.

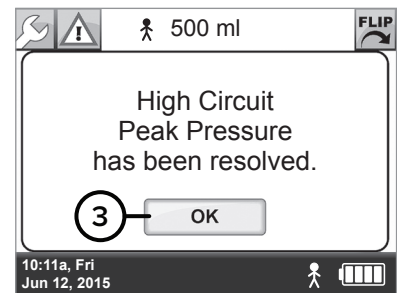

Values displayed on the screen are for illustrative purposes only.

Ventilator alarms

The following tables list high-, medium-, and low-priority alarms. For each alarm, the tables list the notification, the possible causes for the alarm, and possible options for resolving it. The sample screens are for illustrative purposes only.

High-priority alarms

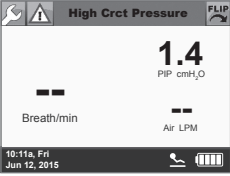
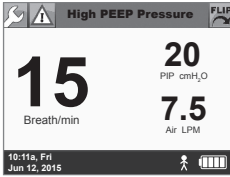
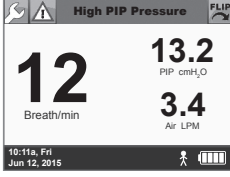
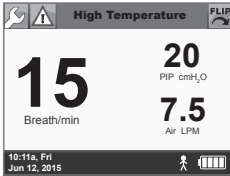
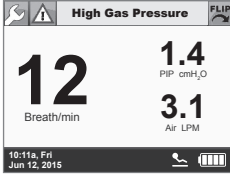
NOTIFICATION	CAUSE	CHECKS AND POSSIBLE RESOLUTION
		STAND-ALONE CONFIGURATION (WEARABLE OUTSIDE HOME)
<p>High Crct Pressure (High Circuit Pressure)</p> 	Interface may be pinched or kinked	<p>Check the interface tubing for pinching or kinking; replace the interface if it is permanently damaged or if the alarm is not resolved.</p>
<p>High PEEP Pressure</p> 	Interface may be blocked	Inspect and clean the interface per the instructions for cleaning the interface.
<p>High PIP Pressure</p> 	Peak Inspiratory Pressure (PIP) exceeds the set limit	<p>Check the interface or tubing for any obstruction.</p> <p>Check all connectors for possible damage.</p> <p>Re-adjust volume setting for the active prescription.</p>
<p>High Temperature</p> 	Ventilator CPU or battery temperature is above the allowable limit	<p>Check to make sure the ventilator is:</p> <ul style="list-style-type: none"> • Not near a heat source. • In a well-ventilated area. • Not covered or enclosed. • Operating within the given operating environmental specifications (see page 111). <p>If the alarm persists, contact your service representative.</p>
<p>High Gas Pressure</p> 	Gas pressure exceeds the allowable limit (20 PSI).	<p>Place the patient on an alternate means of ventilation (if necessary).</p> <p>Ensure that you are using a 50-PSI (nominal) regulator.</p> <p>If the alarm is not resolved, power off the ventilator and contact your service representative</p>

Values displayed on the screens are for illustrative purposes only.

NOTES

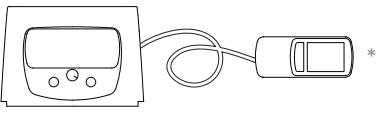
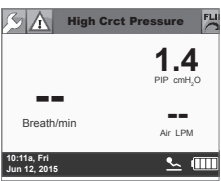
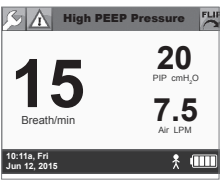
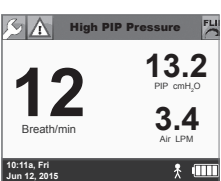
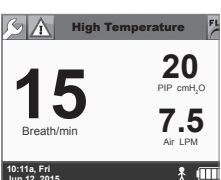
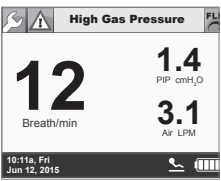

- Options for resolving the alarm are based on the configuration of the ventilation system.
- When attempting to resolve alarm conditions, ensure that the patient receives adequate ventilation therapy; place the patient on an alternate means of ventilation if necessary.

NOTIFICATION	CAUSE	CHECKS AND POSSIBLE RESOLUTION
		EXTENDED RANGE CONFIGURATION (WEARABLE INSIDE HOME)
		 <p>*Ventilators may not be configured with the Battery Charger Dangle.</p>
High Crct Pressure (High Circuit Pressure) 	Interface may be pinched or kinked	Check the interface tubing for pinching or kinking; replace the interface if it is permanently damaged or if the alarm is not resolved.
High PEEP Pressure 	Interface may be blocked	Inspect and clean the interface per the instructions for cleaning the interface.
High PIP Pressure 	Peak Inspiratory Pressure (PIP) exceeds the set limit	Check the interface or tubing for any obstruction. Check all connectors for possible damage. Re-adjust volume setting for the active prescription.
High Temperature 	Ventilator CPU or battery temperature is above the allowable limit	Check to make sure the ventilator is: <ul style="list-style-type: none"> Not near a heat source. In a well-ventilated area. Not covered or enclosed. Operating within the given operating environmental specifications (see page 111). If the alarm persists, contact your service representative.
High Gas Pressure 	Gas pressure exceeds the allowable limit (20 PSI).	Discontinue use of the ventilator. Place the patient on an alternate means of ventilation (if necessary), or connect the ventilator to an alternate pressure source (oxygen cylinder or wall source) in Stand-Alone Configuration. Power off the compressor and contact your service representative.

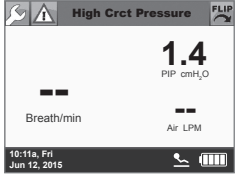
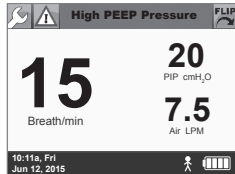
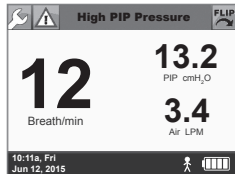
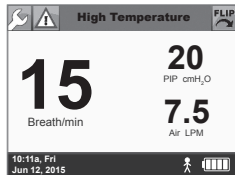
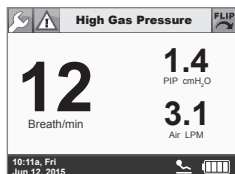

Values displayed on the screens are for illustrative purposes only.

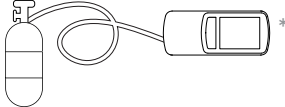
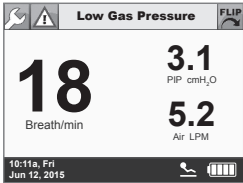
NOTIFICATION	CAUSE	CHECKS AND POSSIBLE RESOLUTION
		STATIONARY CONFIGURATION
<p>High Crct Pressure (High Circuit Pressure)</p> 	Interface may be pinched or kinked	<p>Ensure the ventilator is properly docked into the compressor.</p> <p>Check the interface tubing for pinching or kinking; replace the interface if it is permanently damaged or if the alarm is not resolved.</p>
<p>High PEEP Pressure</p> 	Interface may be blocked	<p>Ensure the ventilator is properly docked into the compressor.</p> <p>Inspect and clean the interface per the instructions for cleaning the interface.</p>
<p>High PIP Pressure</p> 	Peak Inspiratory Pressure (PIP) exceeds the set limit	<p>Ensure the ventilator is properly docked into the compressor.</p> <p>Check the interface or tubing for any obstruction.</p> <p>Check all connectors for possible damage.</p> <p>Re-adjust volume setting for the active prescription.</p>
<p>High Temperature</p> 	Ventilator CPU or battery temperature is above the allowable limit	<p>Check to make sure the compressor is:</p> <ul style="list-style-type: none"> • Not near a heat source. • In a well-ventilated area. • Not covered or enclosed. • Operating within the given operating environmental specifications (see page 111). <p>If the alarm persists, contact your service representative.</p>
<p>High Gas Pressure</p> 	Gas pressure exceeds the allowable limit (20 PSI).	<p>Discontinue use of the ventilator. Place the patient on an alternate means of ventilation (if necessary), or undock the ventilator from the compressor and connect to an alternate pressure source (oxygen cylinder or wall source) in Stand-Alone Configuration.</p> <p>Power off the compressor and contact your service representative.</p>

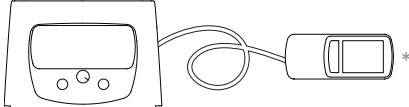
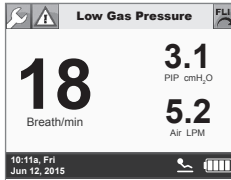

Values displayed on the screens are for illustrative purposes only.

NOTIFICATION	CAUSE	CHECKS AND POSSIBLE RESOLUTION
		<p style="text-align: center;">STAND-ALONE CONFIGURATION (WEARABLE OUTSIDE HOME)</p>  <p style="text-align: center;">*Ventilators may not be configured with the Battery Charger Dongle.</p>
<p>Low Gas Pressure</p>  <p>NOTE Alarm may appear on the screen intermittently.</p>	<p>Gas pressure drops below the allowable limit (20 PSI)</p>	<p>Check all connections for possible leak.</p> <p>Ensure that the source gas supply hose is not kinked or pinched.</p> <p>Ensure you are using a 50-PSI (nominal) regulator with a minimum outlet flow of ≥ 40 LPM at 41 PSI.</p> <p>Ensure the gas source (e.g. cylinder) has a sufficient supply of gas (e.g. check that the cylinder is not empty.)</p> <p>If using a cylinder as the gas source, ensure the cylinder valve is fully open.</p> <p>Connect the ventilator to the compressor in Extended Range or connect the ventilator to another gas source (oxygen cylinder or wall source).</p> <p>If the alarm is not resolved, place the patient on an alternate means of ventilation (if necessary) and contact your service representative.</p>
<p>System Fault</p> 	<p>Internal fault detected during operation</p>	<p>If a system fault occurs, in the message on the touch screen to reboot, touch OK; the ventilator will turn itself off and then on again. Restart ventilation by pressing an Activity Button on the ventilator.</p> <p>If the system fault persists, place the patient on an alternate means of ventilation (if necessary) and contact your service representative.</p>

Values displayed on the screen are for illustrative purposes only.

NOTIFICATION	CAUSE	CHECKS AND POSSIBLE RESOLUTION
		EXTENDED RANGE CONFIGURATION (WEARABLE INSIDE HOME)  *Ventilators may not be configured with the Battery Charger Dongle.
<p>Low Gas Pressure</p>  <p>NOTE Alarm may appear on the screen intermittently.</p>	<p>Gas pressure drops below the allowable limit (20 PSI)</p>	<p>Verify that the compressor is powered on. Check all connections for possible leak. Ensure that the source gas supply hose is not kinked or pinched. If the alarm is not resolved, place the patient on an alternate means of ventilation (if necessary), or connect the ventilator to an alternate pressure source (oxygen cylinder or wall source) in Stand-Alone Configuration. Contact your service representative.</p> <p>The Low Gas Pressure alarm may temporarily sound when switching from an Activity Button with a lower volume to one with a higher volume, the alarm should resolve itself within 60 seconds. Ventilation is still provided while the ventilator is alarming.</p> <p>The Low Gas Pressure alarm may temporarily sound when switching from an Activity Button without PEEP to one with PEEP. The alarm should resolve itself within 60 seconds. Ventilation is still provided while the ventilator is alarming.</p> <p>A 50-foot source gas supply hose may require changing to a 20-foot source gas supply hose, for volumes greater than 350ml.</p>
<p>System Fault</p> 	<p>Internal fault detected during operation</p>	<p>If a system fault occurs, in the message on the touch screen to reboot, touch OK; the ventilator will turn itself off and then on again. Restart ventilation by pressing an Activity Button on the ventilator.</p> <p>If the system fault persists, place the patient on an alternate means of ventilation (if necessary) and contact your service representative.</p>

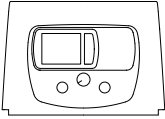
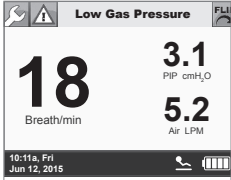
Values displayed on the screens are for illustrative purposes only.

NOTIFICATION	CAUSE	CHECKS AND POSSIBLE RESOLUTION
		 STATIONARY CONFIGURATION
<p>Low Gas Pressure</p>  <p>NOTE Alarm may appear on the screen intermittently.</p>	<p>Gas pressure drops below the allowable limit (20 PSI)</p>	<p>Verify that the compressor is powered on.</p> <p>Ensure the ventilator is properly docked into the compressor.</p> <p>Ensure that the purge tube connector is not connected to the compressor.</p> <p>If the alarm is not resolved, place the patient on an alternate means of ventilation (if necessary), or undock the ventilator from the compressor and connect to an alternate pressure source (oxygen cylinder or wall source) in Stand-Alone Configuration. Contact your service representative.</p> <p>The Low Gas Pressure alarm may temporarily sound when switching from an Activity Button with a lower volume to one with a higher volume, the alarm should resolve itself within 60 seconds. Ventilation is still provided while the ventilator is alarming.</p> <p>The Low Gas Pressure alarm may temporarily sound when switching from an Activity Button without PEEP to one with PEEP. The alarm should resolve itself within 60 seconds. Ventilation is still provided while the ventilator is alarming.</p>
<p>System Fault</p> 	<p>Internal fault detected during operation</p>	<p>If a system fault occurs, in the message on the touch screen to reboot, touch OK; the ventilator will turn itself off and then on again. Restart ventilation by pressing an Activity Button on the ventilator.</p> <p>If the system fault persists, place the patient on an alternate means of ventilation (if necessary) and contact your service representative..</p>

Values displayed on the screens are for illustrative purposes only.

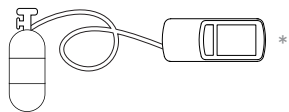
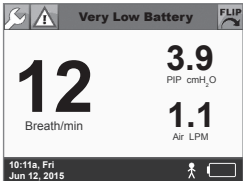
NOTIFICATION	CAUSE	CHECKS AND POSSIBLE RESOLUTION
		STAND-ALONE CONFIGURATION (WEARABLE OUTSIDE HOME)  *Ventilators may not be configured with the Battery Charger Dongle.
Very Low Battery 	Ventilator battery capacity drops below 15%	Connect the ventilator to the ventilator battery charger and an AC power source to recharge the battery. Ensure that the locked icon on the compressor illuminates to indicate the ventilator is charging. Ensure the compressor is powered on. If the battery does not recharge, place the patient on an alternate means of ventilation (if necessary) and contact your service representative.

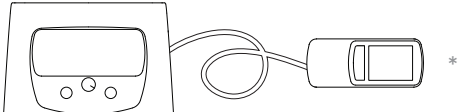
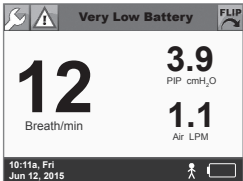
NOTIFICATION	CAUSE	CHECKS AND POSSIBLE RESOLUTION
		EXTENDED RANGE CONFIGURATION (WEARABLE INSIDE HOME)  *Ventilators may not be configured with the Battery Charger Dongle.
Very Low Battery 	Ventilator battery capacity drops below 15%	Connect the ventilator to the ventilator battery charger and an AC power source to recharge the battery. Ensure that the locked icon on the compressor illuminates to indicate the ventilator is charging. Ensure the compressor is powered on. If the battery does not recharge, place the patient on an alternate means of ventilation (if necessary) and contact your service representative.

Values displayed on the screens are for illustrative purposes only.

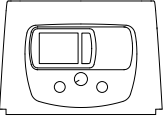
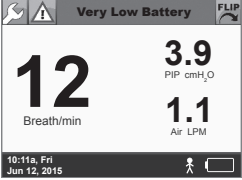
NOTIFICATION	CAUSE	CHECKS AND POSSIBLE RESOLUTION
		 <p>STATIONARY CONFIGURATION</p>
<p>Very Low Battery</p> 	<p>Ventilator battery capacity drops below 15%</p>	<p>Ensure the ventilator is properly docked and locked into the compressor and the locked icon is illuminated to indicate the ventilator is charging.</p> <p>Ensure the compressor is powered on.</p> <p>If the battery does not recharge, place the patient on an alternate means of ventilation (if necessary) and contact your service representative.</p>

Values displayed on the screens are for illustrative purposes only.

Medium-priority alarms

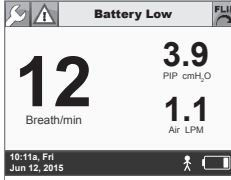
NOTIFICATION	CAUSE	CHECKS AND POSSIBLE RESOLUTION
		STAND-ALONE CONFIGURATION (WEARABLE OUTSIDE HOME)  <small>*Ventilators may not be configured with the Battery Charger Dongle.</small>
Battery Low 	Ventilator battery capacity drops below 25%.	Connect the ventilator to the ventilator battery charger and an AC power source to recharge the battery. Ensure that the locked icon on the compressor illuminates to indicate the ventilator is charging. Ensure the compressor is powered on. If the battery does not recharge, contact your service representative.

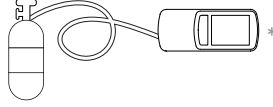
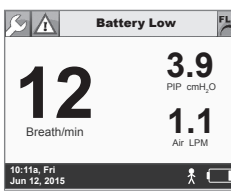
NOTIFICATION	CAUSE	CHECKS AND POSSIBLE RESOLUTION
		EXTENDED RANGE CONFIGURATION (WEARABLE INSIDE HOME)  <small>*Ventilators may not be configured with the Battery Charger Dongle.</small>
Battery Low 	Ventilator battery capacity drops below 25%.	Connect the ventilator to the ventilator battery charger and an AC power source to recharge the battery. Ensure that the locked icon on the compressor illuminates to indicate the ventilator is charging. Ensure the compressor is powered on. If the battery does not recharge, place the patient on an alternate means of ventilation (if necessary) and contact your service representative.

Values displayed on the screens are for illustrative purposes only.

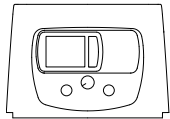
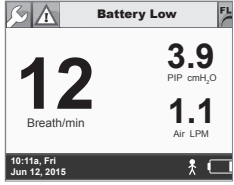
NOTIFICATION	CAUSE	CHECKS AND POSSIBLE RESOLUTION
		 <p>STATIONARY CONFIGURATION</p>
<p>Battery Low</p> 	<p>Ventilator battery capacity drops below 25%.</p>	<p>Ensure the ventilator is properly docked and locked into the compressor and the locked icon is illuminated to indicate the ventilator is charging.</p> <p>Ensure the compressor is powered on.</p> <p>If the battery does not recharge, contact your service representative.</p>

Values displayed on the screens are for illustrative purposes only.

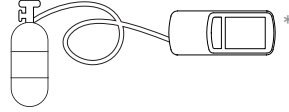
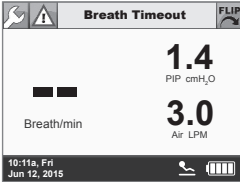
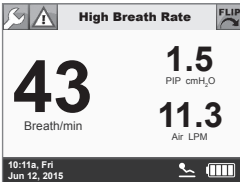
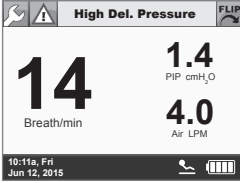
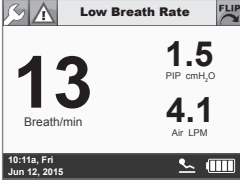
NOTIFICATION	CAUSE	CHECKS AND POSSIBLE RESOLUTION
		STAND-ALONE CONFIGURATION (WEARABLE OUTSIDE HOME)  <small>*Ventilators may not be configured with the Battery Charger Dongle.</small>
Breath Timeout 	No breath is detected for 20 or 60 seconds, depending on the setting.	Patient is not breathing. Patient is breathing through the mouth while using the Breathe Pillows Entrainment Interface. Breaths are too shallow to trigger ventilation; change the trigger sensitivity to a lower setting (higher sensitivity). Ensure patient interface is not leaking at patient side. Inspect and clean the interface per the instructions for cleaning the interface.
High Breath Rate 	Respiratory rate exceeds the set limit.	Patient is breathing faster than the rate set by the clinician. Inspect and clean the interface per the instructions for cleaning the interface. The ventilator may be false triggering because the trigger sensitivity is set too low (in Assist or Assist/Control ventilation mode). Verify the ventilator is syncing with patient effort and adjust trigger sensitivity higher (lower sensitivity).
High Del. Pressure (High Delivery Pressure) 	Interface pressure during delivery exceeds the maximum expected.	Check the interface; replace it if the tubing is torn, bent, or kinked. Ensure the interface tubing is not pinched, crushed, bent, or kinked.
Low Breath Rate 	Respiratory rate falls below set limit.	Patient is breathing through the mouth while using the Breathe Pillows Entrainment Interface. Breaths are too shallow to trigger ventilation; change the trigger sensitivity to a lower setting (higher sensitivity). Ensure patient interface is not leaking at patient side. Inspect and clean the interface per the instructions for cleaning the interface.

Values displayed on the screens are for illustrative purposes only.

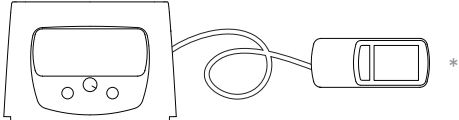
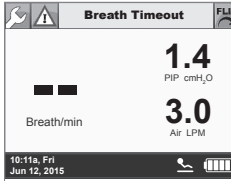
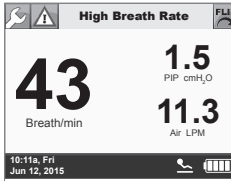
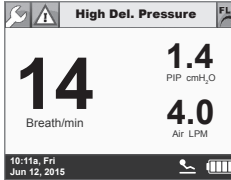
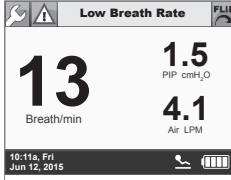
NOTIFICATION	CAUSE	CHECKS AND POSSIBLE RESOLUTION
		<p style="text-align: center;">EXTENDED RANGE CONFIGURATION (WEARABLE INSIDE HOME)</p>  <p style="text-align: center; font-size: small;">*Ventilators may not be configured with the Battery Charger Dongle.</p>
<p>Breath Timeout</p> 	<p>No breath is detected for 20 or 60 seconds, depending on the setting.</p>	<p>Patient is not breathing.</p> <p>Check that the interface is connected to the ventilator, not the compressor.</p> <p>Patient is breathing through the mouth while using the Breathe Pillows Entrainment Interface.</p> <p>Breaths are too shallow to trigger ventilation; change the trigger sensitivity to a lower setting (higher sensitivity).</p> <p>Ensure patient interface is not leaking at patient side.</p> <p>Inspect and clean the interface per the instructions for cleaning the interface.</p>
<p>High Breath Rate</p> 	<p>Respiratory rate exceeds the set limit.</p>	<p>Patient is breathing faster than the rate set by the clinician.</p> <p>Inspect and clean the interface per the instructions for cleaning the interface.</p> <p>The ventilator may be false triggering because the trigger sensitivity is set too low (in Assist or Assist/Control ventilation mode). Verify the ventilator is syncing with patient effort and adjust trigger sensitivity higher (lower sensitivity).</p>
<p>High Del. Pressure (High Delivery Pressure)</p> 	<p>Interface pressure during delivery exceeds the maximum expected.</p>	<p>Check the interface; replace it if the tubing is torn, bent, or kinked.</p> <p>Ensure the interface tubing is not pinched, crushed, bent, or kinked.</p>
<p>Low Breath Rate</p> 	<p>Respiratory rate falls below set limit.</p>	<p>Check that the interface is connected to the ventilator, not the compressor.</p> <p>Patient is breathing through the mouth while using the Breathe Pillows Entrainment Interface.</p> <p>Breaths are too shallow to trigger ventilation; change the trigger sensitivity to a lower setting (higher sensitivity).</p> <p>Ensure patient interface is not leaking at patient side.</p> <p>Inspect and clean the interface per the instructions for cleaning the interface.</p>

Values displayed on the screens are for illustrative purposes only.

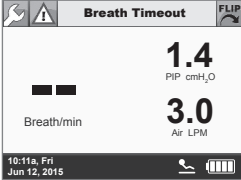
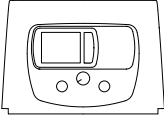
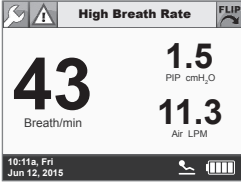
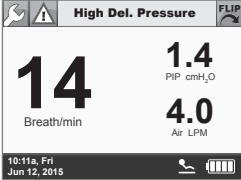
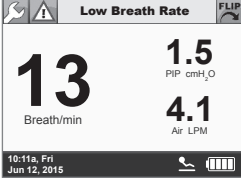
NOTIFICATION	CAUSE	CHECKS AND POSSIBLE RESOLUTION
<p>Breath Timeout</p> 	<p>No breath is detected for 20 or 60 seconds, depending on the setting.</p>	<p style="text-align: center;">STATIONARY CONFIGURATION</p>  <p>Patient is not breathing.</p> <p>Patient is breathing through the mouth while using the Breathe Pillows Entrainment Interface.</p> <p>Breaths are too shallow to trigger ventilation; change the trigger sensitivity to a lower setting (higher sensitivity).</p> <p>Ensure patient interface is not leaking at patient side.</p> <p>Inspect and clean the interface per the instructions for cleaning the interface.</p> <p>Ensure the ventilator is properly docked into the compressor.</p>
<p>High Breath Rate</p> 	<p>Respiratory rate exceeds the set limit.</p>	<p>Patient is breathing faster than the rate set by the clinician.</p> <p>Inspect and clean the interface per the instructions for cleaning the interface.</p> <p>The ventilator may be false triggering because the trigger sensitivity is set too low (in Assist or Assist/Control ventilation mode). Verify the ventilator is syncing with patient effort and adjust trigger sensitivity higher (lower sensitivity).</p>
<p>High Del. Pressure (High Delivery Pressure)</p> 	<p>Interface pressure during delivery exceeds the maximum expected.</p>	<p>Check the interface; replace it if the tubing is torn, bent, or kinked.</p> <p>Ensure the interface tubing is not pinched, crushed, bent, or kinked.</p> <p>Ensure the ventilator is properly docked into the compressor.</p>
<p>Low Breath Rate</p> 	<p>Respiratory rate falls below set limit.</p>	<p>Ensure that the ventilator is properly docked into the compressor.</p> <p>The patient is breathing through the mouth while using the Breathe Pillows Entrainment Interface.</p> <p>Breaths are too shallow to trigger ventilation; change the trigger sensitivity to a lower setting (higher sensitivity).</p> <p>Ensure patient interface is not leaking at patient side.</p> <p>Inspect and clean the interface per the instructions for cleaning the interface.</p>

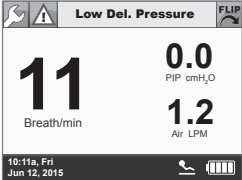
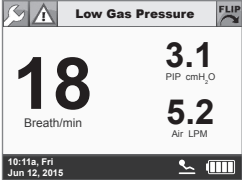
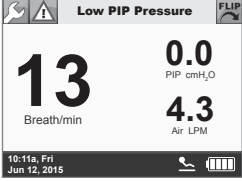
NOTIFICATION	CAUSE	CHECKS AND POSSIBLE RESOLUTION
		STAND-ALONE CONFIGURATION (WEARABLE OUTSIDE HOME)
<p>Low Del. Pressure (Low Delivery Pressure)</p> 	<p>Interface pressure during delivery fails to exceed the minimum expected.</p>	<p>Check the interface connections. Check the interface; replace it if it is leaking.</p>
<p>Low Gas Pressure</p>  <p>NOTE: Alarm may appear on the screen intermittently.</p>	<p>Gas pressure drops below the allowable limit (35 PSI)</p>	<p>Check all connections for possible leak. Ensure that the source gas supply hose is not kinked or pinched. Ensure you are using a 50-PSI (nominal) regulator with a minimum outlet flow of ≥ 40 LPM at 41 PSI. Ensure the gas source (e.g. cylinder) has a sufficient supply of gas (e.g. check that the cylinder is not empty.) If using a cylinder as the gas source, ensure the cylinder valve is fully open. Connect the ventilator to the compressor in Extended Range Configuration or connect the ventilator to another gas source (oxygen cylinder or wall source). If the alarm is not resolved, place the patient on an alternate means of ventilation (if necessary) and contact your service representative.</p>
<p>Low PIP Pressure</p> 	<p>Peak Inspiratory Pressure (PIP) below set limit</p>	<p>Ensure patient interface is not leaking at patient side. Switch to another active Activity Button. If the alarm persists, contact your physician.</p>

Values displayed on the screens are for illustrative purposes only.

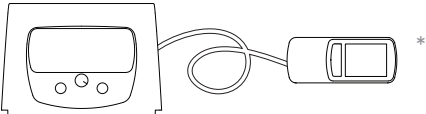
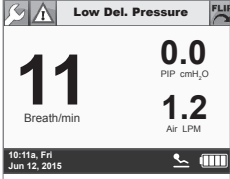
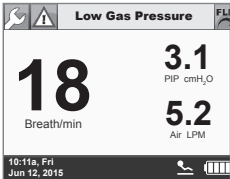
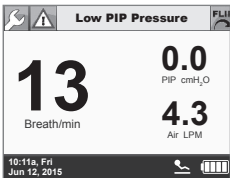
NOTIFICATION	CAUSE	CHECKS AND POSSIBLE RESOLUTION
		EXTENDED RANGE CONFIGURATION (WEARABLE INSIDE HOME)  <small>*Ventilators may not be configured with the Battery Charger Dongle.</small>
<p>Low Del. Pressure (Low Delivery Pressure)</p> 	<p>Interface pressure during delivery fails to exceed the minimum expected.</p>	<p>Check that the interface is connected to the ventilator, not the compressor.</p> <p>Check the interface connections.</p> <p>Check the interface; replace it if it is leaking.</p>
<p>Low Gas Pressure</p>  <p>NOTE: Alarm may appear on the screen intermittently.</p>	<p>Gas pressure drops below the allowable limit (35 PSI)</p>	<p>Verify that the compressor is powered on.</p> <p>Check all connections for possible leak.</p> <p>Ensure that the source gas supply hose is not kinked or pinched.</p> <p>If the alarm is not resolved, place the patient on an alternate means of ventilation (if necessary), or connect the ventilator to an alternate pressure source (oxygen cylinder or wall source) in Stand-Alone Configuration. Contact your service representative.</p> <p>The Low Gas Pressure alarm may temporarily sound when switching from an Activity Button with a lower volume to one with a higher volume, the alarm should resolve itself within 60 seconds. Ventilation is still provided while the ventilator is alarming.</p> <p>The Low Gas Pressure alarm may temporarily sound when switching from an Activity Button without PEEP to one with PEEP. The alarm should resolve itself within 60 seconds. Ventilation is still provided while the ventilator is alarming.</p> <p>A 50-foot source gas supply hose may require changing to a 20-foot source gas supply hose, for volumes greater than 350ml.</p>
<p>Low PIP Pressure</p> 	<p>Peak Inspiratory Pressure (PIP) below set limit</p>	<p>Ensure patient interface is not leaking at patient side.</p> <p>Switch to another active Activity Button.</p> <p>If the alarm persists, contact your physician.</p>

Values displayed on the screens are for illustrative purposes only.

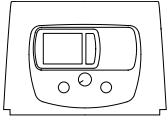
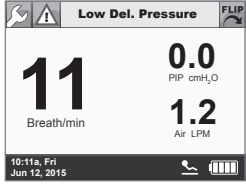
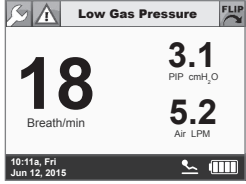
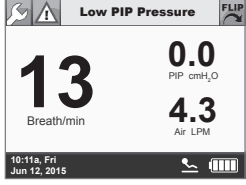
NOTIFICATION	CAUSE	CHECKS AND POSSIBLE RESOLUTION
		 <p>STATIONARY CONFIGURATION</p>
<p>Low Del. Pressure (Low Delivery Pressure)</p> 	<p>Interface pressure during delivery fails to exceed the minimum expected.</p>	<p>Ensure the ventilator is properly docked into the compressor. Check the interface connections. Check the interface; replace it if it is leaking.</p>
<p>Low Gas Pressure</p>  <p>NOTE: Alarm may appear on the screen intermittently.</p>	<p>Gas pressure drops below the allowable limit (35 PSI)</p>	<p>Verify that the compressor is powered on. Ensure the ventilator is properly docked into the compressor. Ensure that the purge tube connector is not connected to the compressor. If the alarm is not resolved, place the patient on an alternate means of ventilation (if necessary), or undock the ventilator from the compressor and connect to an alternate pressure source (oxygen cylinder or wall source) in Stand-Alone Configuration. Contact your service representative. The Low Gas Pressure alarm may temporarily sound when switching from an Activity Button with a lower volume to one with a higher volume, the alarm should resolve itself within 60 seconds. Ventilation is still provided while the ventilator is alarming. The Low Gas Pressure alarm may temporarily sound when switching from an Activity Button without PEEP to one with PEEP. The alarm should resolve itself within 60 seconds. Ventilation is still provided while the ventilator is alarming.</p>
<p>Low PIP Pressure</p> 	<p>Peak Inspiratory Pressure (PIP) below set limit</p>	<p>Ensure patient interface is not leaking at patient side. Ensure the ventilator is properly docked into the compressor. Switch to another active Activity Button. If the alarm persists, contact your physician.</p>

Values displayed on the screens are for illustrative purposes only.

Low-priority alarms

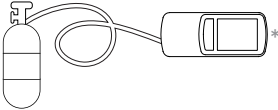
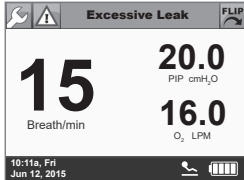
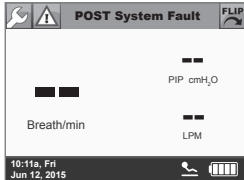
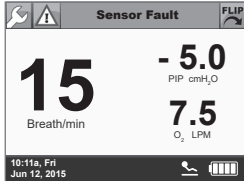
NOTIFICATION	CAUSE	CHECKS AND POSSIBLE RESOLUTION
		STAND-ALONE CONFIGURATION (WEARABLE OUTSIDE HOME)  <small>*Ventilators may not be configured with the Battery Charger Dongle.</small>
Excessive Leak 	An excessive leak is present.	Ensure patient interface or mask is positioned to ensure a proper seal.
POST System Fault 	Power On System Test is a System fault that is detected during ventilator power on.	Power off the ventilator, and power it on again. If the system fault persists, place the patient on an alternate means of ventilation (if necessary) and contact your service representative.
Sensor Fault 	Sensor Fault detected during use of ventilator.	If unable to clear the alarm and the system fault persists, place the patient on an alternate means of ventilation (if necessary) and contact your service representative.

Values displayed on the screens are for illustrative purposes only.

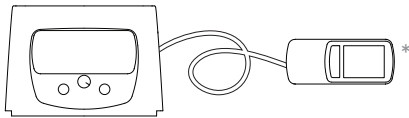
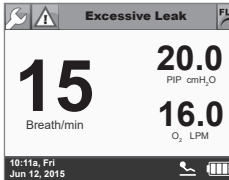
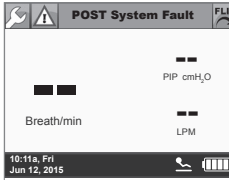
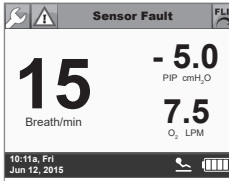
NOTIFICATION	CAUSE	CHECKS AND POSSIBLE RESOLUTION
		<p>EXTENDED RANGE CONFIGURATION (WEARABLE INSIDE HOME)</p>  <p>*Ventilators may not be configured with the Battery Charger Dongle.</p>
<p>Excessive Leak</p> 	<p>An excessive leak is present.</p>	<p>Ensure patient interface or mask is positioned to ensure a proper seal.</p>
<p>POST System Fault</p> 	<p>Power On System Test is a System fault that is detected during ventilator power on.</p>	<p>Power off the ventilator, and power it on again. If the system fault persists, place the patient on an alternate means of ventilation (if necessary) and contact your service representative.</p>
<p>Sensor Fault</p> 	<p>Sensor Fault detected during use of ventilator.</p>	<p>If unable to clear the alarm and the system fault persists, place the patient on an alternate means of ventilation (if necessary) and contact your service representative.</p>

Values displayed on the screens are for illustrative purposes only.

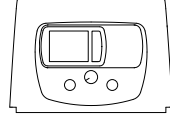
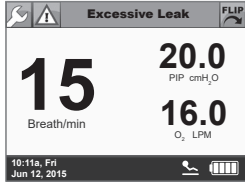
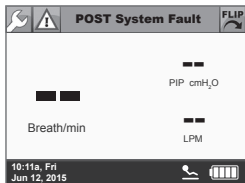
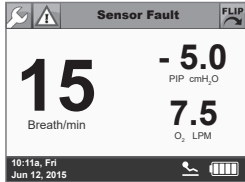
NOTIFICATION	CAUSE	CHECKS AND POSSIBLE RESOLUTION
		 STATIONARY CONFIGURATION
Excessive Leak 	An excessive leak is present.	Ensure patient interface or mask is positioned to ensure a proper seal.
POST System Fault 	Power On System Test is a System fault that is detected during ventilator power on.	Power off the ventilator, and power it on again. If the system fault persists, place the patient on an alternate means of ventilation (if necessary) and contact your service representative.
Sensor Fault 	Sensor Fault detected during use of ventilator.	If unable to clear the alarm and the system fault persists, place the patient on an alternate means of ventilation (if necessary) and contact your service representative.

Values displayed on the screens are for illustrative purposes only.

Compressor alerts

The compressor has alerts that are independent of the ventilator. Compressor alerts must be resolved in order for the compressor alert notifications to be silenced; there is no Silence Alarm button for alerts originating from the compressor.

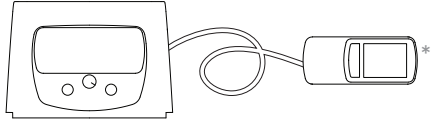
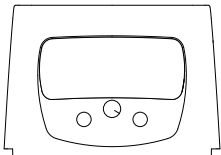
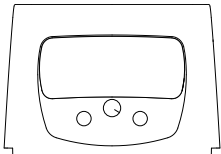
NOTIFICATION	CAUSE	CHECKS AND POSSIBLE RESOLUTION
		EXTENDED RANGE CONFIGURATION (WEARABLE INSIDE HOME)  <small>*Ventilators may not be configured with the Battery Charger Dongle.</small>
Low Battery Alert (Intermittent buzzer) 	Compressor battery capacity drops to 20% or less.	Connect the compressor to an AC power source. If the battery does not recharge, place the patient on an alternate means of ventilation (if necessary) and contact your service representative.
Constant Audible Alert (Compressor stops operating) 	Multiple causes: high motor temperature, high electronics temperature, electronic circuit error, or motor stall.	Discontinue use of the compressor. Place the patient on an alternate means of ventilation (if necessary), or connect the ventilator to an alternate pressure source (oxygen cylinder or wall source) in Stand-Alone Configuration. If running on battery, check the compressor's battery charge status. If the status is less than two indicator lights, connect the compressor to an AC power source. Power off the compressor and power it on again. If the alert persists, power off the compressor and contact your service representative.

NOTES

- Options for resolving the alert are based on the configuration of the ventilation system.
- When attempting to resolve an alert, ensure that the patient receives adequate ventilation therapy; place the patient on an alternate means of ventilation if necessary.

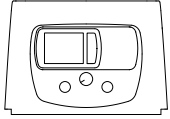
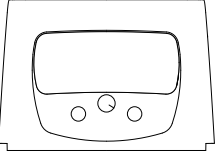
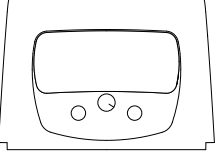
NOTIFICATION	CAUSE	CHECKS AND POSSIBLE RESOLUTION
		 STATIONARY CONFIGURATION
Low Battery Alert (Intermittent buzzer) 	Compressor battery capacity drops to 20% or less.	Connect the compressor to an AC power source. If the battery does not recharge, place the patient on an alternate means of ventilation (if necessary) and contact your service representative.
Constant Audible Alert (Compressor stops operating) 	Multiple causes: high motor temperature, high electronics temperature, electronic circuit error, or motor stall.	Discontinue use of the compressor. Place the patient on an alternate means of ventilation (if necessary), or undock the ventilator from the compressor and connect to an alternate pressure source (oxygen cylinder or wall source) in Stand-Alone Configuration. If running on battery, check the compressor's battery charge status. If the status is less than two indicator lights, connect the compressor to an AC power source. Power off the compressor and power it on again. If the alert persists, power off the compressor and contact your service representative.

NOTES

- Options for resolving the alert are based on the configuration of the ventilation system.
- When attempting to resolve an alert, ensure that the patient receives adequate ventilation therapy; place the patient on an alternate means of ventilation if necessary.

Troubleshooting

The following table lists situations that may occur during normal use of the ventilation system that do not have an alarm associated with them. The possible causes and options for resolving these situations are also listed.

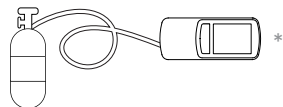
NOTIFICATION	CAUSE	CHECKS AND POSSIBLE RESOLUTION
		STAND-ALONE CONFIGURATION (WEARABLE OUTSIDE HOME)  <small>*Ventilators may not be configured with the Battery Charger Dongle.</small>
Breath indicator light is not syncing with patient breathing or is missing patient breaths	An Activity Button has not been pressed on the ventilator.	Press an Activity Button on the ventilator.
	Patient interface is not connected or is leaking.	Verify that the interface is properly connected to the ventilator and is not leaking at patient side.
	Patient's breath is too shallow to trigger breath.	Change the trigger sensitivity setting to a lower setting (higher sensitivity).
	Patient is mouth breathing while using a Breathe Pillows Entrainment Interface or other nasal mask.	Instruct patient to breathe in through their nose (pursed-lipped breathing is acceptable).
	Secretions may have built up on the interface, blocking the sense port.	Inspect and clean the interface per the instructions for cleaning the interface.
	Patient is breathing faster than 40 BPM.	It is normal for the ventilator to limit breath rate to 40 BPM.
No volume output	Compressor and/or ventilator is not on.	Turn the ventilator on.
	An Activity Button has not been pressed to start therapy.	Press an Activity Button on the ventilator.
	Patient interface is not connected or is leaking.	Verify that the interface is properly connected to the ventilator and is not leaking at patient side.
	Battery is depleted, if running on battery.	Connect the ventilator to the ventilator battery charger and an AC power source and power on the compressor to recharge the battery.
	Ventilator or compressor is inoperative.	If there still is no volume output, contact your service representative.
	Oxygen hose is disconnected.	Reconnect the source gas (oxygen cylinder or wall source) supply.
	Oxygen cylinder is empty.	Replace the oxygen cylinder.
	Incorrect source gas supply hose is being used.	Ensure that a source gas supply hose is connected.

The following table lists situations that may occur during normal use of the ventilation system that do not have an alarm associated with them. The possible causes and options for resolving these situations are also listed.

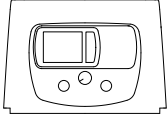
NOTIFICATION	CAUSE	CHECKS AND POSSIBLE RESOLUTION
		 STATIONARY CONFIGURATION
Breath indicator light is not syncing with patient breathing or is missing patient breaths	An Activity Button has not been pressed on the ventilator.	Press an Activity Button on the ventilator.
	Patient interface is not connected or is leaking.	Verify that the interface is properly connected to the compressor and is not leaking at patient side.
	Patient's breath is too shallow to trigger breath.	Change the trigger sensitivity setting to a lower setting (higher sensitivity).
	Patient is mouth breathing while using a Breathe Pillows Entrainment Interface or other nasal mask.	Instruct patient to breathe in through their nose (pursed-lipped breathing is acceptable).
	Secretions may have built up on the interface, blocking the sense port.	Inspect and clean the interface per the instructions for cleaning the interface.
	Patient is breathing faster than 40 BPM.	It is normal for the ventilator to limit breath rate to 40 BPM.
No volume output	Compressor and/or ventilator is not on.	Ensure both the compressor and the ventilator are on.
	An Activity Button has not been pressed to start therapy.	Press an Activity Button on the ventilator.
	Patient interface is not connected or is leaking.	Verify that the interface is properly connected to the compressor and is not leaking at patient side.
	Battery is depleted, if running on battery.	If not plugged in, recharge the battery by connecting the compressor to an AC power source.
	Ventilator or compressor is inoperative.	If there still is no volume output, contact your service representative.
	Oxygen hose is disconnected.	N/A
	Oxygen cylinder is empty.	N/A
Incorrect source gas supply hose is being used.	N/A	

The following table lists situations that may occur during normal use of the ventilation system that do not have an alarm associated with them. The possible causes and options for resolving these situations are also listed.

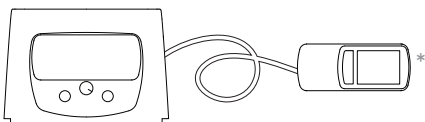
NOTIFICATION	CAUSE	CHECKS AND POSSIBLE RESOLUTION
		EXTENDED RANGE CONFIGURATION (WEARABLE INSIDE HOME)
		 <p>*Ventilators may not be configured with the Battery Charger Dongle.</p>
Breath indicator light is not syncing with patient breathing or is missing patient breaths	An Activity Button has not been pressed on the ventilator.	Press an Activity Button on the ventilator.
	Patient interface is not connected or is leaking.	Verify that the interface is properly connected to the ventilator (not the compressor) and is not leaking at patient side.
	Patient's breath is too shallow to trigger breath.	Change the trigger sensitivity setting to a lower setting (higher sensitivity).
	Patient is mouth breathing while using a Breathe Pillows Entrainment Interface or other nasal mask.	Instruct patient to breathe in through their nose (pursed-lipped breathing is acceptable).
	Secretions may have built up on the interface, blocking the sense port.	Inspect and clean the interface per the instructions for cleaning the interface.
	Patient is breathing faster than 40 BPM.	It is normal for the ventilator to limit breath rate to 40 BPM.
No volume output	Compressor and/or ventilator is not on.	Ensure both the compressor and the ventilator are on.
	An Activity Button has not been pressed to start therapy.	Press an Activity Button on the ventilator.
	Patient interface is not connected or is leaking.	Verify that the interface is properly connected to the ventilator (not the compressor) and is not leaking at patient side.
	Battery is depleted, if running on battery.	Connect the ventilator to the ventilator battery charger and an AC power source and power on the compressor to recharge the battery.
	Ventilator or compressor is inoperative.	If there still is no volume output, contact your service representative.
	Oxygen hose is disconnected.	Reconnect the source gas (oxygen cylinder or wall source) supply.
	Oxygen cylinder is empty.	N/A
	Incorrect source gas supply hose is being used.	Ensure that a source gas supply hose is connected.

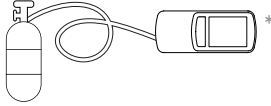
NOTIFICATION	CAUSE	CHECKS AND POSSIBLE RESOLUTION
		STAND-ALONE CONFIGURATION (WEARABLE OUTSIDE HOME)
		 <p>*Ventilators may not be configured with the Battery Charger Dongle.</p>
Breath indicator light is not flashing and there is no volume output	Ventilator is not on.	Ensure ventilator is on.
	A ventilator Activity Button has not been pressed.	Press an Activity Button on the ventilator.
Ventilator is delivering gas without being triggered by patient effort.	Ventilator is in Control or Assist/Control ventilation mode.	It is normal for the ventilator to deliver therapy based on breath rate and breath timeout settings; adjust settings as required.
	The trigger sensitivity is too sensitive.	Adjust trigger sensitivity to a higher number (lower sensitivity).
	Secretions have built up on the interface.	Inspect and clean the interface per the instructions for cleaning the interface.
	Patient interface or connector is damaged.	Check the patient interface and connector for damage and replace if necessary.
Ventilator sometimes misses breaths.	Patient is breathing faster than 40 BPM.	It is normal for the ventilator to limit breath rate to less than 40 BPM.
	Secretions have built up on the interface.	Inspect and clean the interface per the instructions for cleaning the interface.
	Patient interface is not connected or is leaking.	Verify that the interface is properly connected to the ventilator and is not leaking at patient side.
Ventilator is triggering during exhalation.	Secretions have built up on the interface.	Inspect and clean the interface per the instructions for cleaning the interface.
Therapy delivery is causing coughing or irritation in airway.	Interface is not positioned correctly.	Reposition the interface per the instructions in "Connecting an interface" on page 41.
	Patient is breathing against ventilator-triggered breaths.	Switch to another Activity Button. If symptoms persist, contact your physician.
Ventilator battery does not last as long as expected after a charge.	Ventilator battery is not charged completely.	Connect the ventilator to the ventilator battery charger and an AC power source and power on the compressor to recharge the battery.
	Ventilator battery life is nearing its end.	Contact your service representative.
Ventilator screen is unresponsive	Alarm Silence button may be stuck.	Contact your service representative.

NOTES

- Options for resolving the situation are based on the configuration of the ventilation system.
- When attempting to resolve a situation, ensure that the patient receives adequate ventilation therapy; place the patient on an alternate means of ventilation if necessary.

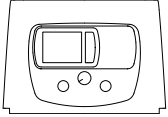
NOTIFICATION	CAUSE	CHECKS AND POSSIBLE RESOLUTION
		 STATIONARY CONFIGURATION
Breath indicator light is not flashing and there is no volume output	Ventilator is not on.	Ensure ventilator is on.
	A ventilator Activity Button has not been pressed.	Press an Activity Button on the ventilator.
Ventilator is delivering gas without being triggered by patient effort.	Ventilator is in Control or Assist/Control ventilation mode.	It is normal for the ventilator to deliver therapy based on breath rate and breath timeout settings; adjust settings as required.
	The trigger sensitivity is too sensitive.	Adjust trigger sensitivity to a higher number (lower sensitivity).
	Secretions have built up on the interface.	Inspect and clean the interface per the instructions for cleaning the interface.
	Patient interface or connector is damaged.	Check the patient interface and connector for damage and replace if necessary.
Ventilator sometimes misses breaths.	Patient is breathing faster than 40 BPM.	It is normal for the ventilator to limit breath rate to less than 40 BPM.
	Secretions have built up on the interface.	Inspect and clean the interface per the instructions for cleaning the interface.
	Patient interface is not connected or is leaking.	Verify that the interface is properly connected to the compressor and is not leaking at patient side.
Ventilator is triggering during exhalation.	Secretions have built up on the interface.	Inspect and clean the interface per the instructions for cleaning the interface.
Therapy delivery is causing coughing or irritation in airway.	Interface is not positioned correctly.	Reposition the interface per the instructions in "Chapter 5: Connecting an Interface".
	Patient is breathing against ventilator-triggered breaths.	Switch to another Activity Button. If symptoms persist, contact your physician.
Ventilator battery does not last as long as expected after a charge.	Ventilator battery is not charged completely.	Recharge the ventilator battery. Check that the ventilator is correctly docked in the compressor and make sure that the ventilator charging indicator light (the locked icon) on the compressor is illuminated when the compressor is on.
	Ventilator battery life is nearing its end.	Contact your service representative.
Ventilator screen is unresponsive	Alarm Silence button may be stuck.	Contact your service representative.

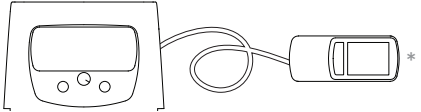
NOTIFICATION	CAUSE	CHECKS AND POSSIBLE RESOLUTION
		EXTENDED RANGE CONFIGURATION (WEARABLE INSIDE HOME)  <small>*Ventilators may not be configured with the Battery Charger Dongle.</small>
Breath indicator light is not flashing and there is no volume output	Ventilator is not on.	Ensure ventilator is on.
	A ventilator Activity Button has not been pressed.	Press an Activity Button on the ventilator.
Ventilator is delivering gas without being triggered by patient effort.	Ventilator is in Control or Assist/Control ventilation mode.	It is normal for the ventilator to deliver therapy based on breath rate and breath timeout settings; adjust settings as required.
	The trigger sensitivity is too sensitive.	Adjust trigger sensitivity to a higher number (lower sensitivity).
	Secretions have built up on the interface.	Inspect and clean the interface per the instructions for cleaning the interface.
	Patient interface or connector is damaged.	Check the patient interface and connector for damage and replace if necessary.
Ventilator sometimes misses breaths.	Patient is breathing faster than 40 BPM.	It is normal for the ventilator to limit breath rate to less than 40 BPM.
	Secretions have built up on the interface.	Inspect and clean the interface per the instructions for cleaning the interface.
	Patient interface is not connected or is leaking.	Verify that the interface is properly connected to the ventilator (not the compressor) and is not leaking at patient side.
Ventilator is triggering during exhalation.	Secretions have built up on the interface.	Inspect and clean the interface per the instructions for cleaning the interface.
Therapy delivery is causing coughing or irritation in airway.	Interface is not positioned correctly.	Reposition the interface per the instructions in "Connecting an interface" on page 41.
	Patient is breathing against ventilator-triggered breaths.	Switch to another Activity Button. If symptoms persist, contact your physician.
Ventilator battery does not last as long as expected after a charge.	Ventilator battery is not charged completely.	Connect the ventilator to the ventilator battery charger and an AC power source and power on the compressor to recharge the battery.
	Ventilator battery life is nearing its end.	Contact your service representative.
Ventilator screen is unresponsive	Alarm Silence button may be stuck.	Contact your service representative.

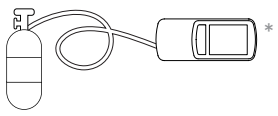
NOTIFICATION	CAUSE	CHECKS AND POSSIBLE RESOLUTION
		<p>STAND-ALONE CONFIGURATION (WEARABLE OUTSIDE HOME)</p>  <p><small>*Ventilators may not be configured with the Battery Charger Dongle.</small></p>
An on-screen alarm flashes on the screen intermittently	Low gas pressure	The cylinder is nearly empty; connect the ventilator to a full cylinder. If the issue persists, contact your service representative.
Ventilator buzzer sounds constantly for two to five minutes and screen goes black	The ventilator battery is damaged.	Contact your service representative.
Ventilator does not turn on	Ventilator battery is completely discharged.	Connect the ventilator to the ventilator battery charger and an AC power source and power on the compressor to recharge the battery. If the issue is not resolved, contact your service representative.
The source gas supply hose does not connect to the gas source.	An incorrect source gas supply hose is being used.	Ensure that an oxygen hose is connected.
	An incompatible regulator is being used.	Ensure the gas regulator is 42-87 PSI with a standard DISS fitting. For any issues with the regulator, contact the regulator manufacturer.
Cylinder does not last as long as expected	User breath rate is higher than expected.	Refer to "Cylinder Duration Information" on page 156.
	Selected Activity Button requires higher volumes of gas.	Obtain a new or larger cylinder.
	Cylinder was not full at the beginning of ventilation.	Obtain a new cylinder.
	The gas regulator is not properly connected to the gas cylinder.	Reconnect the gas regulator to the gas cylinder and verify there are no leaks.
	Flow regulator is on.	Ensure the flow valve is off or set to 0.
	The gas regulator may have a leak.	The regulator sealing washer that connects to the gas cylinder may be worn or damaged. For any issues with the regulator, contact the regulator manufacturer.

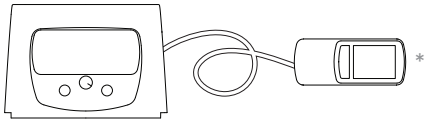
NOTIFICATION	CAUSE	CHECKS AND POSSIBLE RESOLUTION
		EXTENDED RANGE CONFIGURATION (WEARABLE INSIDE HOME)  <small>*Ventilators may not be configured with the Battery Charger Dongle.</small>
An on-screen alarm flashes on the screen intermittently.	Low gas pressure	Contact your service representative.
Ventilator buzzer sounds constantly for two to five minutes and screen goes black.	The ventilator battery is damaged.	Contact your service representative.
Ventilator does not turn on	Ventilator battery is completely discharged.	Connect the ventilator to the ventilator battery charger and an AC power source and power on the compressor to recharge the battery. If the issue is not resolved, contact your service representative.
The source gas supply hose does not connect to the gas source.	An incorrect source gas supply hose is being used.	Ensure you are using an oxygen hose to connect the ventilator to the compressor.

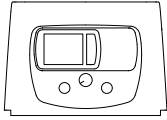
NOTIFICATION	CAUSE	CHECKS AND POSSIBLE RESOLUTION
		 STATIONARY CONFIGURATION
An on-screen alarm flashes on the screen intermittently	Low gas pressure	Contact your service representative.
Ventilator buzzer sounds constantly for two to five minutes and screen goes black	The ventilator battery is damaged.	Contact your service representative.
Ventilator does not turn on	Ventilator battery is completely discharged.	Check that the ventilator is correctly docked in the compressor and make sure that the ventilator charging indicator light (the locked icon) on the compressor is illuminated when the compressor is on.
The source gas supply hose does not connect to the gas source.	An incorrect source gas supply hose is being used.	Connect the compressor to an AC power source. If the issue is not resolved, contact your service representative.
	An incompatible regulator is being used.	N/A
Cylinder does not last as long as expected	User breath rate is higher than expected.	N/A
	Selected Activity Button requires higher volumes of gas.	N/A
	Cylinder was not full at the beginning of ventilation.	N/A
	The gas regulator is not properly connected to the gas cylinder.	N/A
	Flow regulator is on.	N/A
	The gas regulator may have a leak.	N/A

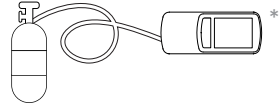
NOTIFICATION	CAUSE	CHECKS AND POSSIBLE RESOLUTION
		STAND-ALONE CONFIGURATION (WEARABLE OUTSIDE HOME)  <small>*Ventilators may not be configured with the Battery Charger Dongle.</small>
Negative PIP value is displayed.	Low PIP	When using the Life2000® Ventilator interfaced with the UCC in conjunction with a full-face mask; when the system is disconnected, the Low PIP alarm will be initiated and a negative value PIP may be displayed.
"Incompatible Settings" message is displayed.	The PEEP or Volume setting is incompatible to maintain clinical settings.	Touch OK and then re-evaluate and readjust the Volume, PEEP, or I-Time setting in the Ventilation Settings screen.
"This Prescription Setting is not active" message is displayed.	The selected Prescription Setting button is not active.	Touch OK and choose another active Prescription Setting button to change the currently-ventilating prescription.
"Connect Oxygen Source" or "Disconnect Oxygen Source" message is displayed.	A reminder to verify that the correct source gas is connected	Verify that the correct source gas is connected, then press OK to begin ventilating.

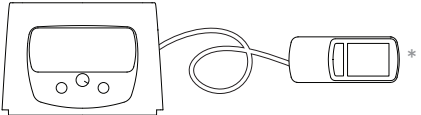
NOTIFICATION	CAUSE	CHECKS AND POSSIBLE RESOLUTION
		EXTENDED RANGE CONFIGURATION (WEARABLE INSIDE HOME)  <small>*Ventilators may not be configured with the Battery Charger Dongle.</small>
Negative PIP value is displayed.	Low PIP	When using the Life2000® Ventilator interfaced with the UCC in conjunction with a full-face mask; when the system is disconnected, the Low PIP alarm will be initiated and a negative value PIP may be displayed.
"Incompatible Settings" message is displayed.	The PEEP or Volume setting is incompatible to maintain clinical settings.	Touch OK and then re-evaluate and readjust the Volume, PEEP, or I-Time setting in the Ventilation Settings screen.
"This Prescription Setting is not active" message is displayed.	The selected Prescription Setting button is not active.	Touch OK and choose another active Prescription Setting button to change the currently-ventilating prescription.
"Connect Oxygen Source" or "Disconnect Oxygen Source" message is displayed.	A reminder to verify that the correct source gas is connected	Verify that the correct source gas is connected, then press OK to begin ventilating.

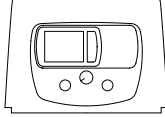
NOTIFICATION	CAUSE	CHECKS AND POSSIBLE RESOLUTION
		 STATIONARY CONFIGURATION
Negative PIP value is displayed.	Low PIP	When using the Life2000® Ventilator interfaced with the UCC in conjunction with a full-face mask; when the system is disconnected, the Low PIP alarm will be initiated and a negative value PIP may be displayed.
"Incompatible Settings" message is displayed.	The PEEP or Volume setting is incompatible to maintain clinical settings.	Touch OK and then re-evaluate and readjust the Volume, PEEP, or I-Time setting in the Ventilation Settings screen.
"This Prescription Setting is not active" message is displayed.	The selected Prescription Setting button is not active.	Touch OK and choose another active Prescription Setting button to change the currently-ventilating prescription.
"Connect Oxygen Source" or "Disconnect Oxygen Source" message is displayed.	A reminder to verify that the correct source gas is connected	Verify that the correct source gas is connected, then press OK to begin ventilating.

Maintenance

Cleaning before first use

It is not necessary to clean or sterilize the Life2000® Ventilation System before the first use.

Daily checks

Look at the ventilation system components daily. If any of the following conditions are discovered, discontinue use of the ventilation system:

- Check for cracks in the casing.
- Check for loose or damaged buttons, connectors, or other control and alarm components.
- Check the interface and the source gas supply hose (if applicable) for leaks and loose or damaged cabling or connectors.

Daily, or more often if necessary, check and empty the compressor's condensation tray and replace if necessary. For more information, see "Checking and replacing the condensation tray" on page 120.

Essential Performance:

- Absence of system fault alarms
- Unintended change of settings and modes
- Absence of false alarms
- No interruption of operation without alarms.

If damage is discovered, discontinue use of the ventilation system or do not begin using the ventilation system. For instructions on servicing or replacing damaged ventilation system components, contact your service representative.

Environmental specifications

Do not use the ventilation system if the ambient temperature is greater than 40°C (104°F) or less than 5°C (41°F). Store the ventilation system in ambient temperatures less than 60°C (140°F) and greater than -20°C (-4°F).



WARNING

The back of the ventilator enclosure may reach 49°C in a 40°C environment.

Alarm checks

Confirm that when the ventilator is powered on, it makes audible tones. If tones are not heard, the ventilator should be returned to your service representative.

Cleaning and disinfecting the ventilation system

Power off the ventilation system before cleaning and disinfecting it. Ensure that the patient receives adequate ventilation therapy; place the patient on an alternate means of ventilation if necessary. Using a clean cloth, clean and disinfect the external surfaces of the ventilation system with:

- Clorox Disposable Wipes
- PDI Super Sani-Cloth® Germicidal Disposable Wipes
- 70% isopropyl alcohol
- Virex II



NOTES

- Always follow the cleaning manufactures suggested wait time before you wipe off the residue.
- Wipe the surface of the ventilation system with clean dry cloth to remove any residual cleaner.
- Do not clean the ventilation system with petrochemical or oil-based materials.
- Clean the touch screen with a soft microfiber cloth and disinfect with PDI Super Sani-Cloth® Germicidal Disposable Wipes as necessary. After allowing for the manufacturer's suggested wait time, wipe the screen with clean cloth to remove any residual cleaner.



CAUTIONS

- 70% isopropyl alcohol or Virex II may damage the touch screen. When cleaning external surfaces of the ventilation system with 70% isopropyl alcohol or Virex II, avoid contact with the touch screen.
- Keep in a clean environment to protect the ventilation system from ingress of dust, lint, and pests.
- Do not leave exposed to the sun or other sources of radiant heat, it may overheat.
- Do not allow children or pets to access the ventilation system; it may become damaged.

Cleaning for single patient use

Ventilation system

- ① Once a week, or more often if necessary, follow the instructions found in the "Cleaning and disinfecting the ventilation system" on page 112.
- ② Daily, or more often if necessary, check and empty the compressor's condensation tray and replace if necessary. For more information, see "Checking and replacing the condensation tray" on page 120.
- ③ Every three to six months, or more often if necessary, check the compressor's air inlet filter and replace if necessary. For more information, see "Checking and replacing the air inlet filter" on page 121.
- ④ Every three to six months, or more often if necessary, check the compressor's cooling filter assembly and replace if necessary. For more information, see "Checking and replacing the cooling filter assembly" on page 122.

Oxygen hoses

For single patient use in the home care environment, it is recommended to replace the hose every six months. If dirt is visible on the outside of the hose, use a clean cloth and mild detergent such as dishwashing soap to remove it. To disinfect the hoses, use a clean cloth, clean and disinfect the external surfaces of the hoses with the cleaners listed below:

- Clorox Disposable Wipes
- PDI Super Sani-Cloth® Germicidal Disposable Wipes
- 70% isopropyl alcohol
- Virex II



NOTES

- Always follow the cleaning manufactures suggested wait time before you wipe off the residue.
- Wipe the surface of the ventilation system with clean dry cloth to remove any residual cleaner.



WARNING

Do not subject source gas supply hoses to heat sterilization, hot water pasteurization, autoclaving, radiation sterilization, ethylene oxide gas sterilization, or attempt to clean them in a dishwasher or microwave oven. Doing any of these may damage the hoses and impair gas delivery.

Breathe Pillows Entrainment Interface and Universal Circuit® Connector

Once a week, or more often if necessary, follow the instructions found in the "Cleaning the breathe interfaces" section of this chapter.

Third-party patient mask or tube

Follow the manufacturer's instructions.

Cleaning for multi-patient use



To prevent risk of cross-contamination, clean and disinfect the ventilation system before using it on a new patient, and use a new Breathe Pillows Entrainment Interface or Universal Circuit® Connector. For the third-party patient mask, refer to the user guide provided by the manufacturer. Replace the oxygen hose between patients.

In addition to the cleaning and maintenance instructions for single-patient use, you must perform the following before the ventilation system is provided to a new patient.

Ventilation system

- ① Follow the instructions in "Cleaning and disinfecting the ventilation system" on page 112.
- ② Replace the compressor's condensation tray.
For more information, see "Checking and replacing the condensation tray" on page 120.
- ③ Replace the compressor's air inlet filter.
For more information, see "Checking and replacing the air inlet filter" on page 121.
- ④ Replace the compressor's cooling filter assembly.
For more information, see "Checking and replacing the cooling filter assembly" on page 122.

Oxygen hoses

Replace between patients.

Breathe Pillows Entrainment Interface

Replace between patients.

Universal Circuit® Connector

Replace between patients.

Third-party patient mask or tube

Follow the manufacturer's instructions.

Purge tube connector

Replace between patients.

Cleaning the breathe interfaces

NOTE

Below instructions are for cleaning Breathe interfaces. If using a third-party patient mask or tube, please refer to the manufacturer's suggested cleaning instructions.

- If mucous accumulates on the patient interface, use a clean cloth to remove it.
- If dirt is visible on the outside of the interface, use a clean cloth and mild detergent such as dishwashing soap to remove it.

WARNING

Do not subject Breathe interfaces to heat sterilization, hot water pasteurization, autoclaving, radiation sterilization, ethylene oxide gas sterilization, or attempt to clean them in a dishwasher or microwave oven. Doing any of these may damage the interfaces and impair gas delivery.

Before cleaning

- 1 Place the patient on an alternate means of ventilation, if necessary.
- 2 Power off the ventilator and compressor.
- 3 Disconnect the interface from the ventilation system.

Clean the interface

- 4 Submerge the patient side of the Breathe Pillows Entrainment Interface or the patient side of the Universal Circuit® Connector in a clean container of mixed warm water suitable for drinking and a mild detergent (e.g., dishwashing soap) and agitate the patient side of the interface to clean it.

Rinse the patient side of the interface thoroughly with warm water.

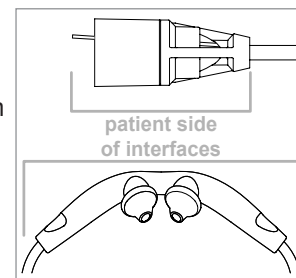

Purge the interface

- 5 Perform a purge immediately after the rinse to completely dry the interface and to clear any excess water that may impede air flow. For purging instructions, see the section "Purging the Universal Circuit® Connector" or "Purging the Breathe Pillows Entrainment Interface" on the next pages.

Dry the interface

- 6 Hang the Breathe Pillows Entrainment Interface or the Universal Circuit® Connector to completely dry in a location away from direct sunlight.

Purge the interface again

- 7 Before reusing the interface, perform a second purge to clear any excess water that may impede air flow. For purging instructions, see the section "Purging the Universal Circuit® Connector" or "Purging the Breathe Pillows Entrainment Interface" on the next pages.

Purging the Universal Circuit® Connector

After cleaning and completely drying the interface or when you suspect dust or debris has entered the airflow passage, purge the interface with the purge tube connector and purge tube.

 **NOTE**

The ventilator is not required for the purging process.

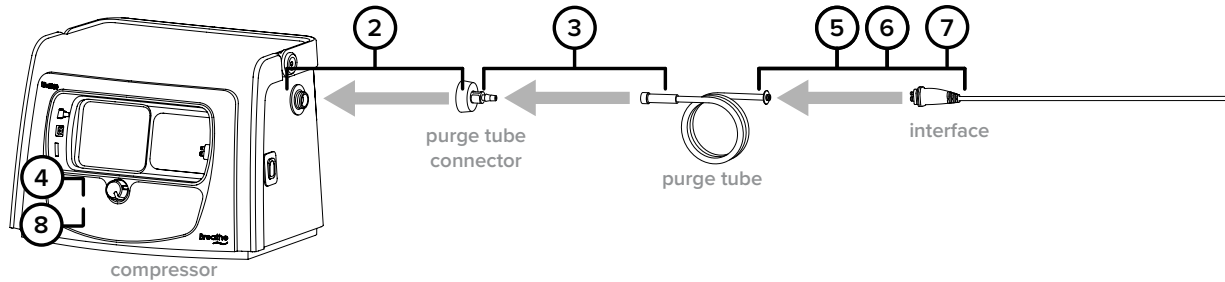

- 1 Place the patient on an alternate means of ventilation, if necessary.
- 2 Connect the purge tube connector to the outlet fitting on the compressor by twisting on.
- 3 Connect the larger end of the purge tube to the barbed outlet of the purge tube connector by twisting on until secure.

 **NOTE**

Ensure that the purge tube is not twisted or kinked.

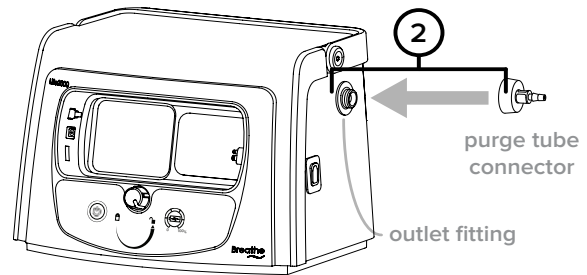

- 4 Power on the compressor.
 - 5 Firmly press and hold the smaller end of the purge tube over one of the interface ports that connects the interface to the compressor.
- Hold the purge tube over the interface port until all the water is purged from the tube.

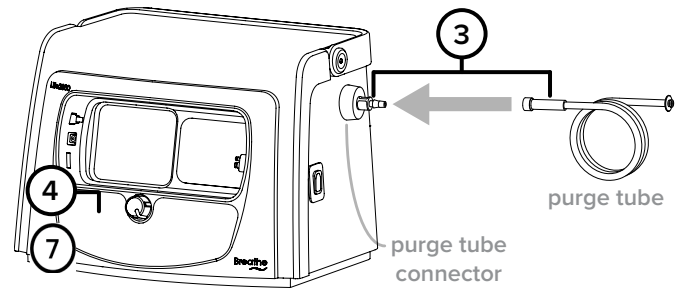

 **NOTE**

Take care not to slide the tube over the O-ring of the port.

- 6 Repeat step 5 for the other interface port.
- 7 Power off the compressor.

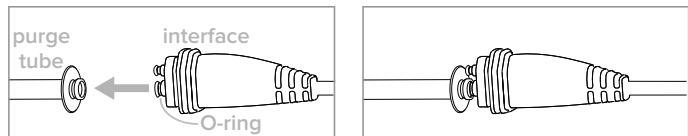

- 8 Twist to remove the purge tube from the purge tube connector.
- 9 Remove the purge tube connector from the compressor.

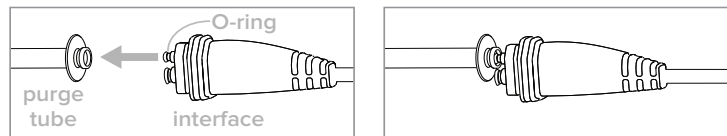

- 10 Store the purge tube and purge tube connector for future use.

Purging the Breathe Pillows Entrainment Interface

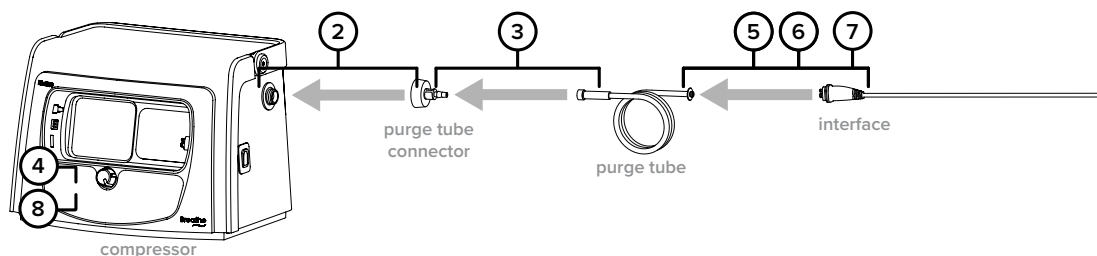

- 1 Place the patient on an alternate means of ventilation, if necessary.
- 2 Connect the purge tube connector to the outlet fitting on the compressor by twisting on.

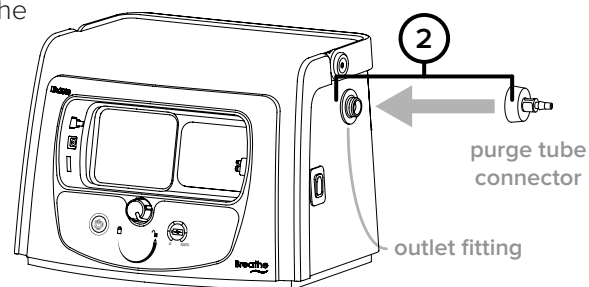

- 3 Connect the larger end of the purge tube to the barbed outlet of the purge tube connector by twisting on until secure.



NOTE

Ensure that the purge tube is not twisted or kinked.

- 4 Power on the compressor.

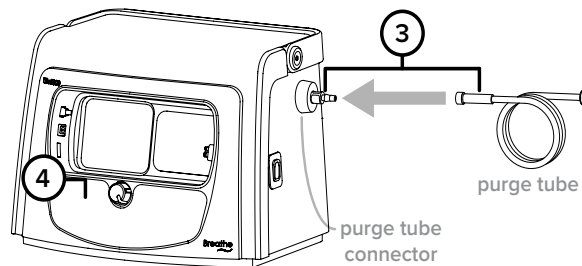

- 5 Firmly press and hold the smaller end of the purge tube over one of the interface ports that connect the interface to the compressor.



NOTE:

Take care not to slide the tube over the O-ring of the port.

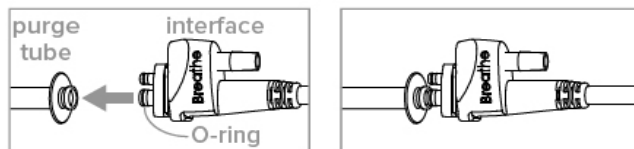

Hold the purge tube over the interface port until all the water is purged from the tube.

- 6 Repeat step 5 for the other interface port.

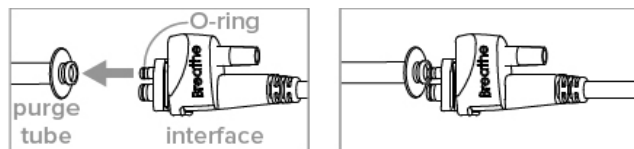

- 7 Firmly press the smaller end of the purge tube over the oxygen tubing connection on the interface.

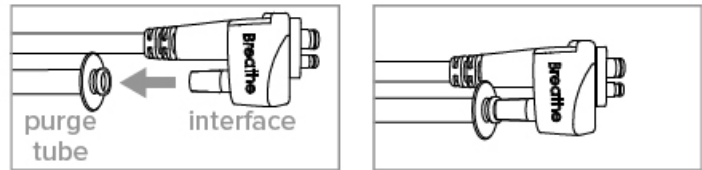

- 8 Power off the compressor.

- 9 Twist to remove the purge tube from the purge tube connector.

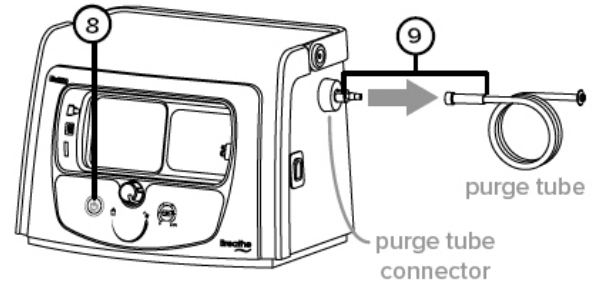

- 10 Remove the purge tube connector from the compressor.

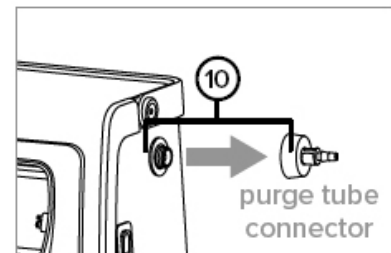

- 11 Store the purge tube and purge tube connector in a clean place for future use.

Preventive maintenance

WARNING

Unauthorized modifications can result in equipment damage, or patient injury or death.

CAUTION

No user serviceable components are inside the device; do not attempt to repair any components inside the device.

Contact your service representative to make arrangements for preventive maintenance, service, and component replacement per the chart below.

REVISION	VENTILATOR	COMPRESSOR
Before Revision C	2.5 Years from ship date	1 Year from ship date
Revision C and after	2.5 Years from ship date	2.5 Years from ship date

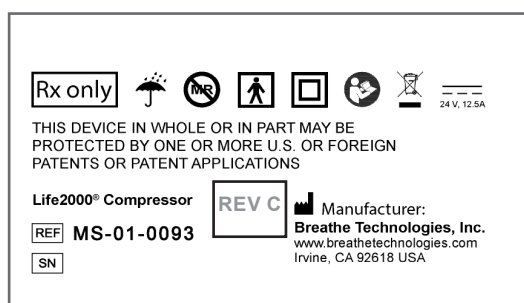

The ventilation system can only be serviced or repaired by an authorized service center. Trained personnel and authorized service centers are provided with the proper documentation to maintain the ventilation system.

When shipping the ventilation system, use proper packaging for protection.

NOTE

The compressor contains a lithium ion battery. Before shipping the compressor, contact your transportation carrier for information.

TIP

The ventilation system is shipped in specially designed, protective boxes. Do not throw away the boxes; keep them for future transportation needs.

Battery replacement

Contact your service representative to make arrangements for replacing the ventilator or compressor battery if battery runtime degrades to an unacceptable level. The batteries can only be serviced or repaired by an authorized service center.

Checking and replacing the condensation tray

The condensation tray collects water condensate from humidity in the air.

Check the condensation tray daily, or more frequently if needed. The frequency that the condensation tray needs to be checked and emptied will depend on the amount of humidity in the ambient air. The more humidity that is in the air, the more frequently the condensation tray will need to be checked, emptied, and replaced.



NOTE

The compressor is shipped with a condensation tray already installed.

- ① Place the patient on an alternate means of ventilation.
- ② If operating in Extended Range Configuration, power off the ventilator.
- ③ Power off the compressor.

- ④ Twist the thumb screw counterclockwise until the tray is released.
- ⑤ Carefully slide the condensation tray out from the back of the compressor, attempting to keep the condensation tray level.

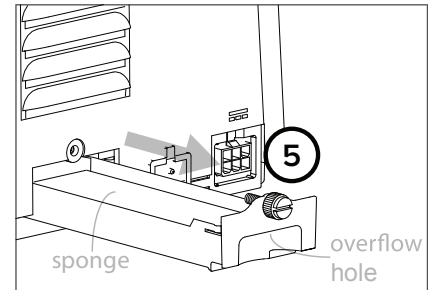
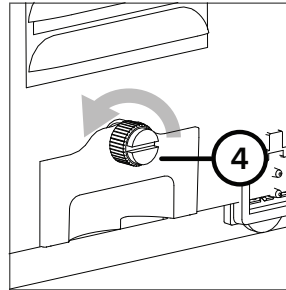

- ⑥ If water has collected in the condensation tray, completely remove the condensation tray from the compressor and empty the water thoroughly. Squeeze the attached condensation tray sponge to remove as much water as possible (some remaining dampness is normal).



NOTE

Do not try to remove the sponge from the condensation tray.

- ⑦ Ensure that the overflow hole is not blocked.
- ⑧ Inspect the condensation tray and replace it if it has any damage or if the sponge shows signs of degradation, contamination, or odor. If replacing the condensation tray, obtain a replacement condensation tray. For more information about purchasing replacement condensation trays, refer to "Appendix" on page 155.
- ⑨ Insert the condensation tray into the compressor.
- ⑩ Tighten the thumb screw by twisting it clockwise until the condensation tray is secure.

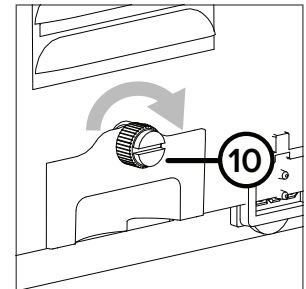
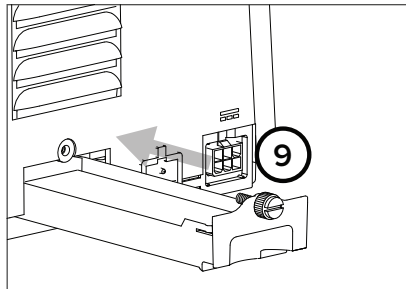

NOTE

Dispose of used condensation trays in accordance with your facility's guidelines or local regulations.



WARNINGS

- Do not power on or use the compressor without the filters and condensation tray properly installed.
- Do not insert foreign objects into any part of the ventilation system.



CAUTION

Use only an approved condensation tray with the compressor.

Checking and replacing the air inlet filter

The air inlet filter is used to filter ambient air entering through the back of the compressor.

The compressor air inlet filter needs to be changed every three to six months, or as needed.

NOTE

The compressor is shipped with an air inlet filter already installed.

- 1 Place the patient on an alternate means of ventilation.
- 2 Power off the ventilator.
- 3 Power off the compressor.
- 4 To inspect the filter, locate the filter on the back of the unit.
- 5 Remove the used filter and inspect the filter.
Replace the filter if it is blocked by dirt or dust or is otherwise contaminated. If replacing the filter, obtain an approved replacement filter. For more information about purchasing replacement filters, refer to "Appendix" on page 155.
- 6 If the filter is clean, return it to the back of the compressor.

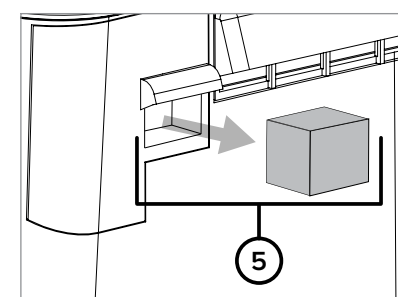
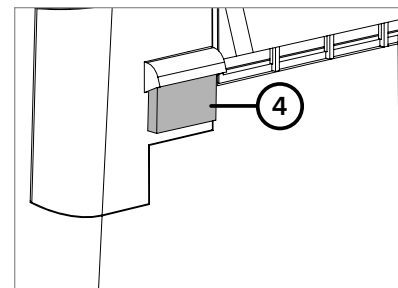

NOTES

- Reusing contaminated filters is not recommended.
- Dispose of used filters in accordance with your facility's guidelines or local regulations.
- The filter might need to be changed more frequently in particulate-filled environments.

WARNINGS

- Do not power on or use the compressor without the filters and condensation tray properly installed.
- Do not insert foreign objects into any part of the ventilation system.

CAUTION

Use only an approved filter with the compressor.

Checking and replacing the cooling filter assembly

The cooling filter is used to filter air that enters the compressor to cool it during operation.

The cooling filter assembly (including the cooling filter and cooling filter cover) needs to be changed every three to six months, or as needed.

NOTE

The compressor is shipped with a cooling filter assembly already installed.

- ① Place the patient on an alternate means of ventilation.
- ② If operating in Stationary or Extended Range Configuration, power off the ventilator.
- ③ Power off the compressor.
- ④ Locate the cooling filter cover on the back of the compressor.
- ⑤ Remove the cooling filter assembly by pulling the cooling filter cover directly out from the back of the compressor.

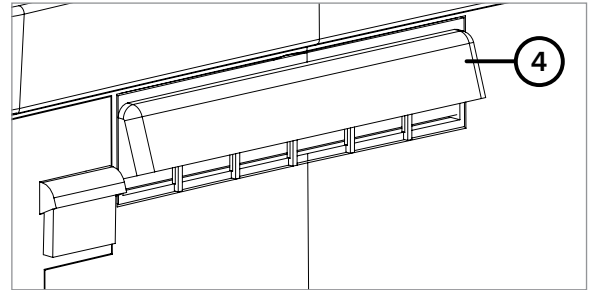

- ⑥ Inspect the used cooling filter.
Replace the cooling filter assembly if the filter is blocked by dirt or dust or is otherwise contaminated. If replacing the cooling filter assembly, obtain a replacement. For more information about purchasing replacement parts, refer to "Appendix" on page 155.
- ⑦ Replace the cooling filter assembly on the back of the compressor by pushing it back into place until it is secure.

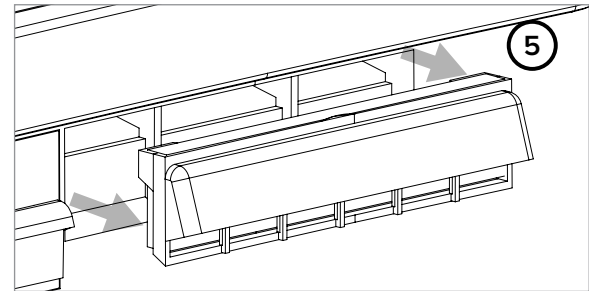

NOTES

- Reusing contaminated filters is not recommended.
- Dispose of used filters in accordance with your facility's guidelines or local regulations.
- The filter might need to be changed more frequently in particulate-filled environments.

WARNINGS

- Do not power on or use the compressor without the filters and condensation tray properly installed.
- Do not insert foreign objects into any part of the ventilation system.

CAUTION

Use only an approved filter with the compressor.

Testing ventilator alarms

This section gives instructions for testing ventilator alarms. Procedures described in this section are only to be performed by trained personnel.

Connect the ventilator to an AC power source or ensure the battery has sufficient charge before beginning testing.

If any test fails, contact your service representative.

Verifying power-on self-test alarms

- 1 Press the Power button to turn on the ventilator.
- 2 Verify that there are audible tones while powering on the ventilator.

Verifying backup alarm buzzer

- 1 With the ventilator powered on and source gas connected and set to 50 psig, press an available Activity Button on the ventilator. The top of the touch screen should display a Low Gas Pressure Alarm and you should hear a sequence of three tones.
- 2 Allow the ventilator to continue to alarm. After 70 seconds, the alarm should sound with an additional buzzer and the breath light indicator will illuminate red to indicate the alarm has not been silenced.
- 3 Power off the ventilator.

Testing alarm conditions

Do not test while the ventilator is being used on a patient.

NOTE

These testing procedures require clinical settings to be changed. If necessary, record clinical settings before beginning.

For each test verify both corresponding alarm notifications occur and are correct:

- ① The visual alarm appears on the touch screen, and
- ② The audio alarm is audible, or the ventilator vibrates if in vibration mode.

NOTE

Other alarms and/or multiple alarms may occur during the testing procedure. If a different alarm occurs from the one you're testing for, use the **Active Alarms** button on the touch screen to display the alarm list. The alarm you are testing for may be listed in the list of additional alarms. For more information, see "Alarms, alerts, and troubleshooting" on page 76.

Touch to display active alarms

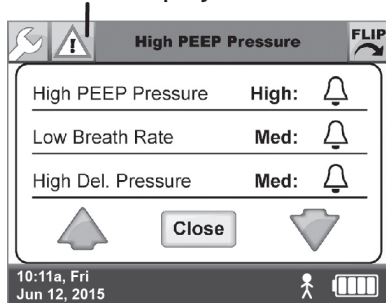

As long as the alarm you are testing for is listed, the test may be considered complete.

If the alarm is not listed, turn off the ventilator, and turn it back on. Check that the test settings are correct and repeat the test.

Equipment required for testing

- ① The Life2000® Ventilator
- ② An adjustable gas source connected to an adjustable regulator (to test the High Gas Pressure alarm, both must be able to reach 95 PSI). Either oxygen or air may be used for testing.

NOTE

The Life2000® Compressor is not an adjustable air source.

- ③ An interface
(The Breathe Pillows Entrainment Interface or Universal Circuit® Connector may be used for testing.)

NOTE

The interface will be handled during testing. Thoroughly clean the testing interface before using it on patient or purchase the Life2000® Performance Verification Testing Kit. For information about ordering accessories and replacement parts, see "Appendix" on page 155.

Testing setup

- ① Power on the ventilator.
- ② If necessary, record clinical settings before changing settings.
- ③ Using the Clinician's Menu, activate only the **Low Activity Prescription Setting**.

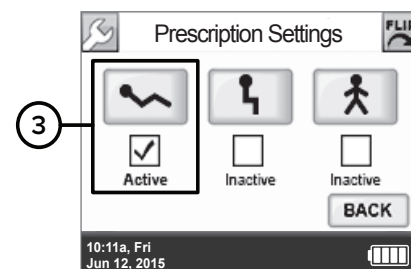

- ④ Set the **Ventilation Settings** to:
- ⑤ Set the **Alarm Limits** to:
- ⑥ Set the **Breath Timeout** to:

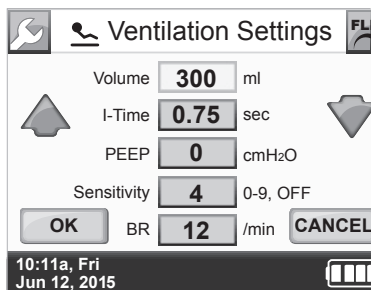

Touch **OK** and then **CONFIRM**.

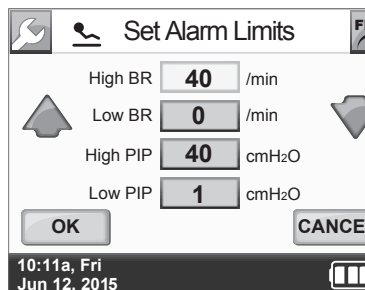

Touch **OK** and then **CONFIRM**.

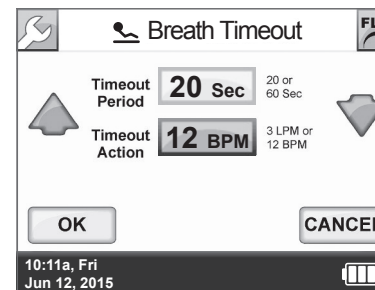

Touch **OK** and then **CONFIRM**.

- ⑦ Set the **Source Gas** to whatever source gas is being used for testing.

- ⑧ Connect the adjustable source gas supply to the ventilator using an adjustable regulator set to 50 PSI. Turn on the source gas supply to 50 PSI nominal.

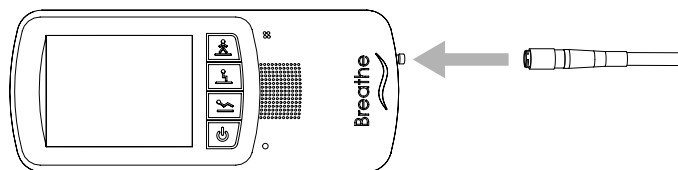

*Ventilators may not be configured with the Battery Charger Dongle.

- ⑨ Connect the interface. For more information, see "Connecting an interface" on page 41.

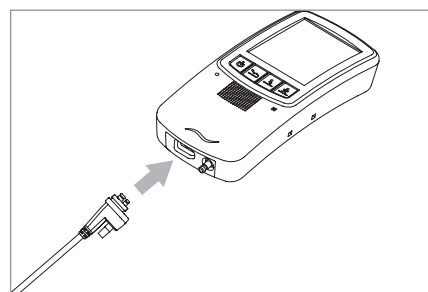

NOTE

The interface does not need to be worn during testing. Place the ventilator on a flat surface where the interface connection will not be jostled. Set the interface aside, with nasal pillows and tubing free of anything that might impede air flow.

Testing the Low Gas Pressure alarm (Medium priority)

- 1 Begin by ventilating using the Low Activity button. Allow the ventilator to ventilate for a few breaths using the current settings.
- 2 Disconnect the source gas supply hose from the ventilator connection by pulling back on the knurled ring until the hose detaches.
- 3 The top of the touch screen should display the Low Gas Pressure alarm (in yellow), and you should hear a sequence of three tones indicating a medium-priority alarm or vibrate.

NOTE

If a low- or medium-priority alarm occurs while the ventilator is in vibration mode, and the alarm is not resolved within 60 seconds, an audible alarm occurs.

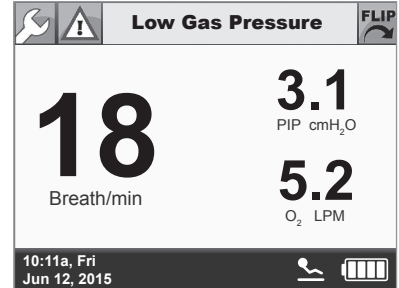

Values displayed on the screen are for illustrative purposes only.

- 4 After verifying the correct alarm notifications, reattach the source gas supply hose to the ventilator.

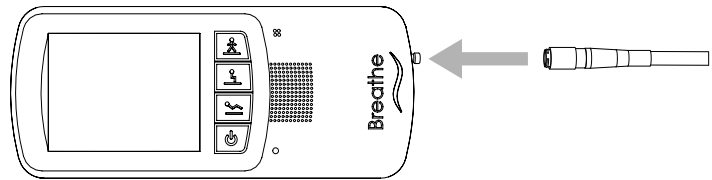

The Low Gas Pressure alarm will resolve itself once the gas supply is correctly reattached.

*Ventilators may not be configured with the Battery Charger Dongle.

Testing the High Delivery Pressure alarm (Medium priority)

- 1 Begin by ventilating using the Low Activity button. Allow the ventilator to ventilate for a few breaths using the current settings.
- 2 As soon as the breath indicator light shows a breath being delivered by the ventilator, quickly pinch the interface tubing near the ventilator connection.
- 3 The top of the touch screen should display the High Delivery Pressure (High Del. Pressure) alarm (in yellow), and you should hear a sequence of three tones indicating a medium-priority alarm or vibrate.

NOTE

If a low- or medium-priority alarm occurs while the ventilator is in vibration mode, and the alarm is not resolved within 60 seconds, an audible alarm occurs.

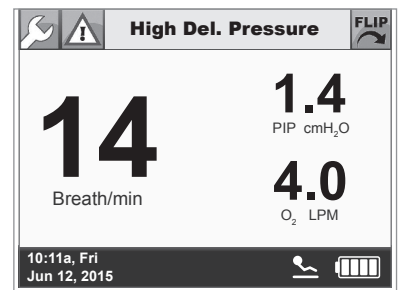

Values displayed on the screen are for illustrative purposes only.

- 4 After verifying the correct alarm notifications, release the interface tubing. The High Delivery Pressure alarm will resolve itself once the interface has been released.

Testing the Low PIP alarm (Medium priority) and Low Delivery Pressure alarm (Medium priority)

- 1 Begin by ventilating using the Low Activity button. Allow the ventilator to ventilate for a few breaths using the current settings.
- 2 Disconnect the interface from the ventilator.
- 3 The top of the touch screen should display the Low PIP Pressure alarm (in yellow), and you should hear a sequence of three tones indicating a medium-priority alarm or vibrate.

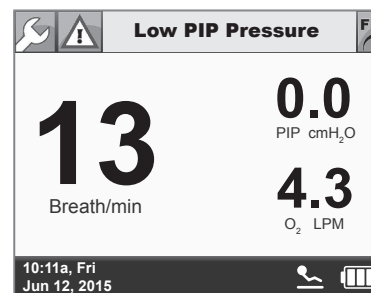

Values displayed on the screen are for illustrative purposes only.

- 4 Use the active alarms button at the top of the touch screen to display the active alarms window; the Low Del. Pressure alarm should be listed in the list of alarms.

NOTE

If a low- or medium-priority alarm occurs while the ventilator is in vibration mode, and the alarm is not resolved within 60 seconds, an audible alarm occurs.

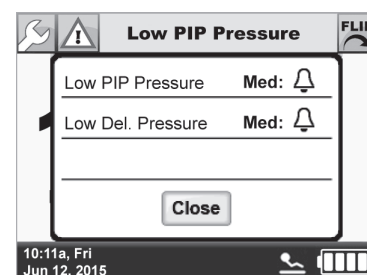
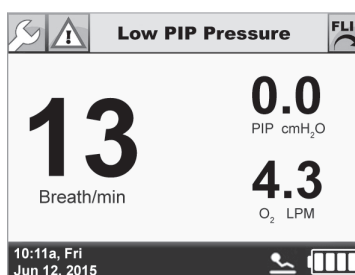

Values displayed on the screens are for illustrative purposes only.

- 5 After verifying the correct alarm notifications, reconnect the interface to the ventilator.

The alarms should resolve themselves once the interface is correctly reattached.

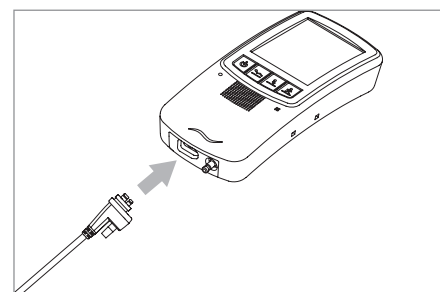

- 6 Close the active alarm list by touching the **Close** button.

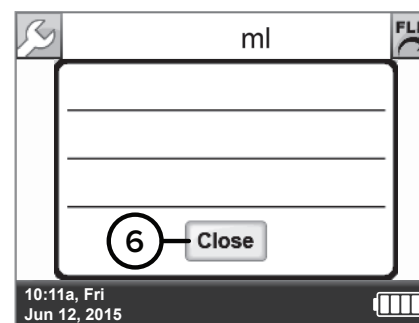

Testing the High PIP alarm (High priority)

- 1 Begin by ventilating using the Low Activity button. Allow the ventilator to ventilate for a few breaths using the current settings.
- 2 Using the **Clinician's Settings Menu**, navigate to the **Low Activity Prescription Set Alarm Limits** and change the **High PIP** alarm limit to 10 cmH₂O. Select **OK** and **CONFIRM**.

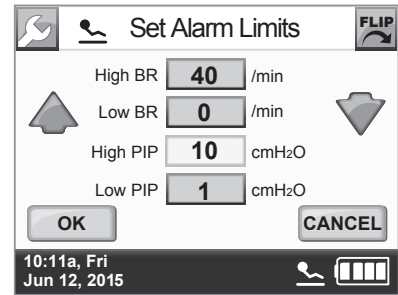

- 3 If testing with the Universal Circuit® Connector, completely plug the large opening on the patient side of the interface using the palm of your hand. Or, if testing with the Breathe Pillows Entrainment Interface, use your thumbs to completely plug the nasal pillows until the ventilator alarms.
- 4 The top of the touch screen should display the **High PIP Pressure** alarm (in red), and you should hear a sequence of two sets of five tones indicating a high priority alarm.

NOTE

For a high-priority alarm, an audible tone immediately occurs with a vibration alarm with no delay.

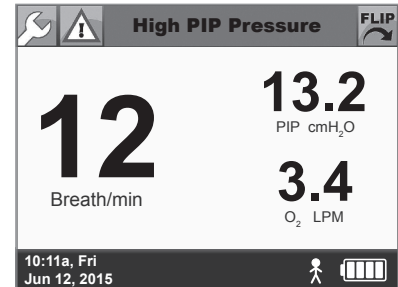

Values displayed on the screen are for illustrative purposes only.

- 5 After verifying the correct alarm notifications for the High PIP alarm, release the interface and allow the alarm to resolve itself.
- 6 Using the **Clinician's Settings Menu**, navigate to the **Low Activity Prescription Set Alarm Limits** and return the **High PIP** alarm limit to 40 cmH₂O. Select **OK** and **CONFIRM**.

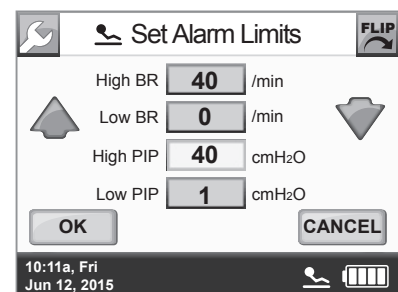

Testing the Breath Timeout alarm (Medium priority) and High Circuit Pressure alarm (High priority)

- 1 Begin by ventilating using the Low Activity button. Allow the ventilator to ventilate for a few breaths using the current settings.
- 2 Using the **Clinician's Settings Menu**, navigate to **Ventilation Settings** and change the **BR** setting to 0/min. Select **OK** and **CONFIRM**.

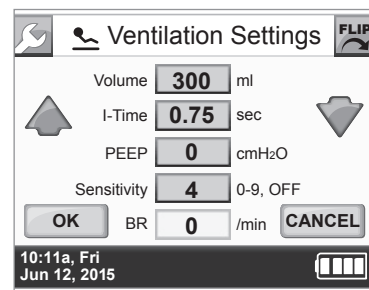

- 3 Wait up to 20 seconds to allow the Breath Timeout to trigger. The top of the touch screen should display the Breath Timeout alarm (in yellow), and you should hear a sequence of three tones indicating a medium-priority alarm or vibrate.



NOTES

- The High Del. Pressure alarm may appear before the Breath Timeout alarm.
- If a low- or medium-priority alarm occurs while the ventilator is in vibration mode, and the alarm is not resolved within 60 seconds, an audible alarm occurs.

- 4 After verifying the correct alarm notifications for the Breath Timeout alarm, kink (try to impede air flow) the interface tubing near the connection to the ventilator.

- 5 Within a few seconds the top of the touch screen should display the High Circuit Pressure (High Crct Pressure) alarm (in red), and you should hear a sequence of two sets of five tones indicating a high priority alarm.



NOTE

For a high-priority alarm, an audible tone immediately occurs with a vibration alarm with no delay.

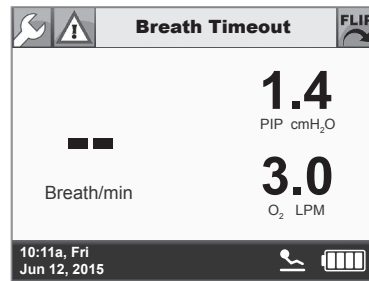

Values displayed on the screen are for illustrative purposes only.

- 6 After verifying the correct alarm notifications for the High Circuit Pressure alarm, release the interface tubing and allow the High Circuit Pressure alarm to resolve itself.

Touch **OK** in the message that indicates the alarm has been resolved.

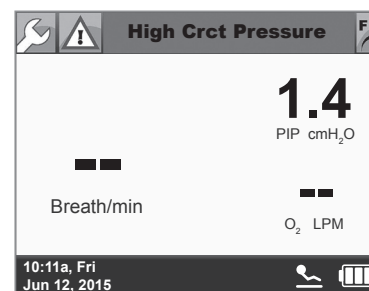

Values displayed on the screen are for illustrative purposes only.

- 7 Using the **Clinician's Settings Menu**, navigate to **Ventilation Settings** and return the **BR** setting to 12/min. Select **OK** and **CONFIRM**.

The **Breath Timeout** alarm will resolve itself once the setting is changed.

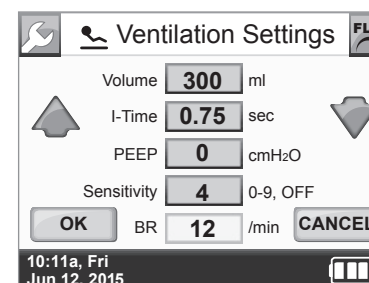
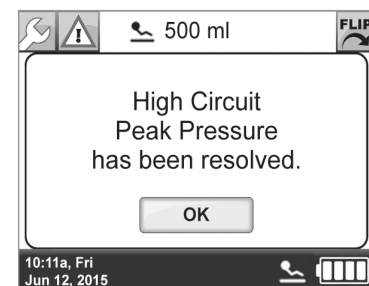

Testing the High Breath Rate alarm (Medium Priority)

1 Begin by ventilating using the Low Activity button. Allow the ventilator to ventilate for a few breaths using the current settings.

2 Using the **Clinician's Settings Menu**, navigate to **Low Activity Prescription Set Alarm Limits** and change the **High BR** alarm limit to 20/min. Select **OK** and **CONFIRM**.

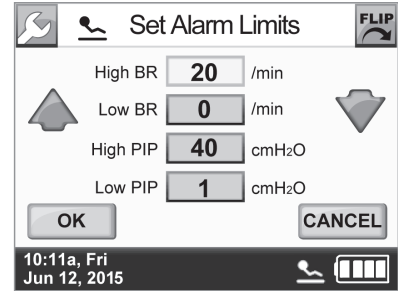

3 Repeatedly pinch the interface tubing near the ventilator to impede, but not completely stop, airflow. Pinch more than once every three seconds to alarm.

4 The top of the touch screen should display the **High Breath Rate** alarm (in yellow), and you should hear a sequence of three tones indicating a medium-priority alarm or vibrate.

NOTE

If a low- or medium-priority alarm occurs while the ventilator is in vibration mode, and the alarm is not resolved within 60 seconds, an audible alarm occurs.

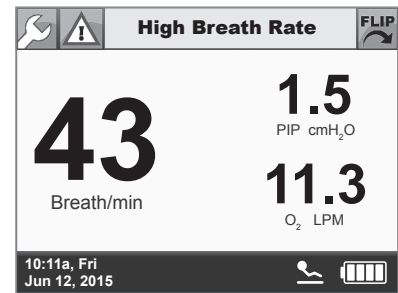

Values displayed on the screen are for illustrative purposes only.

5 After verifying the correct alarm notifications, release the interface tubing. The High Breath Rate alarm will resolve itself within a few breaths.

6 Using the **Clinician's Settings Menu**, navigate to **Set Alarm Limits** and return the **High BR** alarm limit to 40/min. Select **OK** and **CONFIRM**.

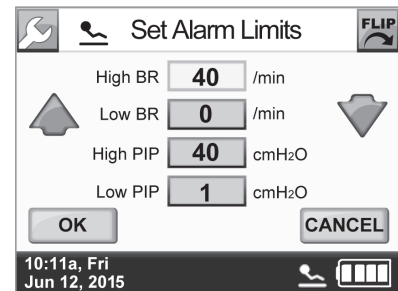

Testing the Low Breath Rate alarm (Medium priority)

- 1 Begin by ventilating using the Low Activity button. Allow the ventilator to ventilate for a few breaths using the current settings.
- 2 Using the **Clinician's Settings Menu**, navigate to **Low Activity Prescription Set Alarm Limits** and change the **Low BR** alarm limit to 20/min. Select **OK** and **CONFIRM**.

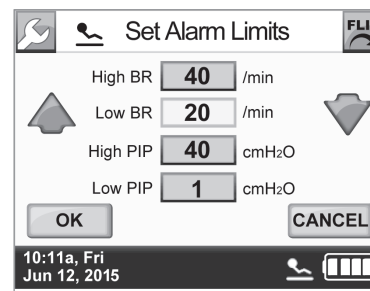

- 3 The top of the touch screen should display the Low Breath Rate alarm (in yellow), and you should hear a sequence of three tones indicating a medium-priority alarm or vibrate.

NOTE

If a low- or medium-priority alarm occurs while the ventilator is in vibration mode, and the alarm is not resolved within 60 seconds, an audible alarm occurs.

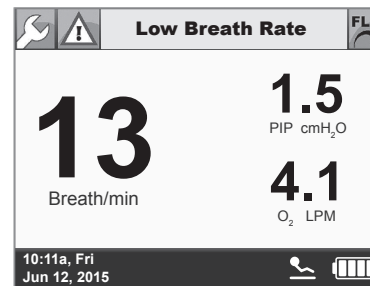

Values displayed on the screen are for illustrative purposes only.

- 4 Using the **Clinician's Settings Menu**, navigate to **Set Alarm Limits** and return the **Low BR** alarm limit to 0/min. Select **OK** and **CONFIRM**.

The **Low BR** alarm will resolve itself when the **Low BR** alarm limit is returned to 0/min.

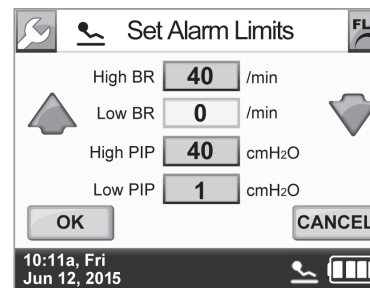

Testing the Battery Low alarm (Medium-priority) and Very Low Battery alarm (High-priority)

- ① If the ventilator is connected to an AC power source, disconnect the ventilator from the power source so it is running on its internal battery.
- ② Ventilate by using the High Activity button.
- ③ Allow the ventilator to ventilate until the Battery Low Alarm occurs (25% battery charge).
- ④ The top of the touch screen should display the Battery Low alarm (in yellow) and you should hear a sequence of three tones indicating a medium-priority alarm or vibrate.



NOTE

If a low- or medium-priority alarm occurs while the ventilator is in vibration mode, and the alarm is not resolved within 60 seconds, an audible alarm occurs.

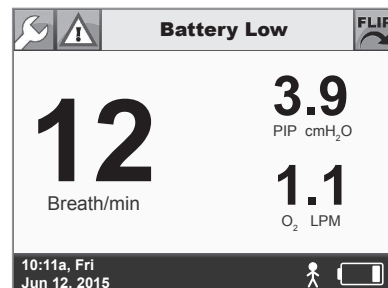

Values displayed on the screen are for illustrative purposes only.

- ⑤ After verifying the correct alarm notifications for the Battery Low alarm, allow the ventilator to continue ventilating using High Activity. The ventilator will continue to alarm for the Battery Low alarm until the Very Low Battery alarm occurs (15% battery charge).
- ⑥ When the Very Low Battery alarm occurs, the screen should display the Very Low Battery alarm (in red), and you should hear a sequence of two sets of five tones indicating a high priority alarm.



NOTE

For a high-priority alarm, an audible tone immediately occurs with a vibration alarm with no delay.

- ⑦ After verifying the correct alarm notifications for the Very Low Battery alarm, connect the ventilator to an AC power source and allow the internal battery to recharge.

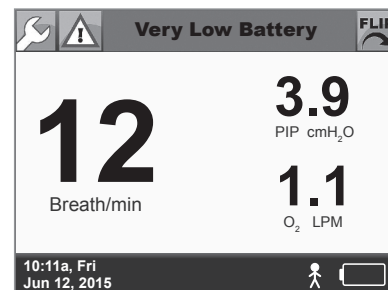

Values displayed on the screen are for illustrative purposes only.

After checking alarm conditions

After testing has been completed successfully, program clinical settings for patient use and make sure that the ventilator has sufficient charge before using it on a patient.

Battery information

Checking the Ventilator Battery Charge

- 1 Ensure that the ventilator is powered on.
- 2 Check the Ventilator Battery Charge icon on the touch screen to see the current battery charge level for the ventilator. Refer to the chart below to determine the approximate amount of ventilator battery charge.



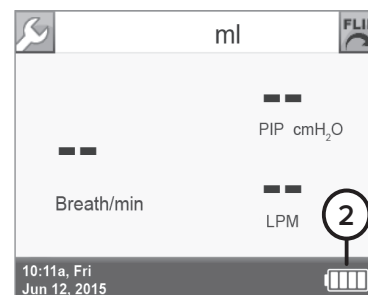



When the ventilator is connected to AC, the ventilator battery charge icon should display either the charging icon or the icon for 100% charged.



 **NOTE**

There may be a delay of up to 20 seconds before the Ventilator Battery Charge icon appears on the touch screen.

Ventilator Battery Charge icons, meanings, and approximate time remaining

BATTERY CHARGE ICON							
APPROX. CHARGE AMOUNT	Charging*	< 5%	< 15%	15–35%	36–56%	57–79% 57-84%>>	80–100% 85-100%>>
APPROX. TIME REMAINING	N/A	Critically low. Recharge immediately.	Less than 0.5 hour. [†] ** Recharge immediately.	0.5–1.5 Hours ^{†**}	1.5-2.5 hours ^{**}	2.5-3 hours ^{**}	3-4 hours ^{**}
			Less than 0.75 hour. [†] Recharge immediately.	0.75–2 Hours [‡] >	2-3.25 hours>	3.25-5 hours>	5-6 hours>

Approximate Time Remaining is based on the following ventilator settings: BR 12, Volume 350, PEEP 0, I-Time 1.0

**Applicable to Ventilator REF MS-01-0100

> Applicable to Ventilator REF MS-01-0118

>>Applicable to Software version 5.12.00 or 06.06.00 or greater

* The charging icon may still appear when the ventilator is 100% charged.

† Very low battery alarm will sound with less than 15% charge.

‡ Low battery alarm will sound with less than 25% charge.

Ventilator battery specifications

The Life2000® Ventilation System uses lithium ion batteries with the following specifications:

SPECIFICATION	DESCRIPTION
Type	Lithium ion, rechargeable, not user replaceable.
Ampere/hour rating	1800 mAh
Maximum current	450 mA
Operating Voltage	7.4 V internal
Duration	Approximately 5-6 hours*
Ventilator	If the battery performance degrades to unacceptable levels contact your service representative.

The approximate time remaining is based on the following ventilator settings:
BR 12, Volume 350, PEEP 0, I-Time 1.0

TIPS

- *For Ventilator REF MS-01-0118 a fully charged battery in good condition is designed to operate for 6 hours of typical use, but exact operating time depends on patient breath rate.
- *For Ventilator REF MS-01-0100 a fully charged battery in good condition is designed to operate for 5 hours of typical use, but exact operating time depends on patient breath rate.
- If the battery has no charge, it takes approximately three to four hours to fully recharge.
- The ventilator can be used while charging.
- The ventilator sounds an alarm and displays an alarm message when the battery has less than 25% of its charge and then again when it has less than 15%.



Compressor battery charge status

When the compressor is powered on, the indicator lights in the battery charge scale are visible. When the compressor is powered off, press and hold the battery charge status button to display the battery charge scale indicator lights.

The behavior of the indicator lights in the battery charge scale display is different if the compressor is connected to an AC power source or running on its internal battery.

When the compressor is powered by internal battery

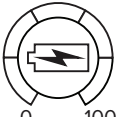
 When the compressor is powered on and running on its internal battery, the indicator lights surrounding the compressor's power button are illuminated in orange.

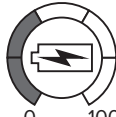
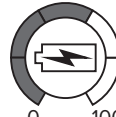
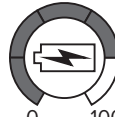
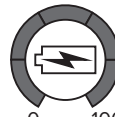
BATTERY CHARGE SCALE						
APPROX. CHARGE AMOUNT	0%	1–20%*	21–50%	51–70%	71–90%	91–100%

* The compressor's low battery alarm will sound when its internal battery charge drops to 20% or less.

When the compressor is connected to AC power



When the compressor is powered on and connected to AC power, the indicator lights surrounding the compressor's power button are illuminated in green.



TIP

When the compressor's internal battery is charging, the blinking indicator light (✱) shows the current level of charge.

BATTERY CHARGE SCALE						
APPROX. CHARGE AMOUNT	0–20%	21–50%	51–70%	71–90%	91–99%	100%

Compressor battery specifications

SPECIFICATION	DESCRIPTION
Type	Lithium ion, rechargeable, not user replaceable.
Ampere/hour rating	10200 mAh
Maximum current	10 A
Operating Voltage	28.8 V internal
Duration	1 hour
Compressor	If the battery performance degrades to unacceptable levels, contact your service representative.



NOTE

The compressor contains a lithium ion battery. Before shipping or traveling with the compressor, contact your transportation carrier for information.



TIPS

- A fully charged battery in good condition is designed to operate for one hour of typical use, but exact operating time depends on usage conditions.
- If the battery has no charge, it takes approximately three to four hours to fully recharge.
- A fully charged battery in good condition lasts one hour.
- The compressor can be used while charging.
- The compressor sounds an alarm when the battery charge drops to 20% or less.

Ventilator battery charger and power cord specifications

Ventilator battery charger specifications

CATEGORY	SPECIFICATION
Input AC voltage	100-240 VAC
Input AC frequency	50-60 Hz
Input AC current	0.3 A max.
Output DC voltage	8.4 VDC
Output DC current	1.3 A
Insulation class	Class II
Electrical safety approvals	UL 60601-1, EN 60950, EN 60601-1, EN 60335-2-29
Dimensions	3.55" x 1.77" x 1.26" (90 x 45 x 32 mm)
Weight	0.25 lb. (0.115 kg)

Ventilator power cord specifications

6 ft. IEC 320-E7 compliant cord

Compressor power supply and power cord specifications

Compressor power supply specifications

CATEGORY	SPECIFICATION
Input AC voltage	100-240 VAC
Input AC frequency	50-60 Hz
Input AC current	5 A max. at 100 VAC 2.5 A max. at 240 VAC
Output DC voltage	24 VDC
Output DC current	12.5 A
Insulation class	Class II
Ingress protection rating	IP22
Electrical safety approvals	ANSI/AAMI ES60601-1, cUL ES60601-1, TUV EN60601-1 3rd edition
Dimensions	7.8" x 4" x 2" (198 x 102 x 51 mm)
Weight	3 lb. (1.36 kg)

Compressor power cord specifications

6 ft. IEC 320-C13 compliant cord

Specifications

Oxygen monitor

**WARNING:**

To ensure accuracy of oxygen administration and to monitor for the presence of contamination (incorrect gas connected), use an external oxygen monitor to verify the oxygen concentration in the delivered gas.

Recommended oxygen monitor: Teledyne™ MX300, or similar.

To set high and low alarms for oxygen concentration and for installation information, refer to the manufacturer's instructions.

The Tee Adapter will be connected between the Universal Circuit® Connector and the patient mask.

**NOTE**

The clinician shall ensure that the patient is getting sufficient oxygen.

Exhalation volume monitor

**WARNING**

To monitor minute volume, use an external exhaled volume monitor.

Recommended flow monitors: Ohmeda® 5420, Respironics® NM3™, Datex-Ohmeda® Cardiocap™/5, or similar.

For installation information, refer to the manufacturer's instructions.

The in-line adapter will be connected between the Universal Circuit® Connector and the patient mask.

Ventilator altitude volume adjustment table

The volume output by the ventilator is not automatically adjusted for altitude. The following table shows the typical calculated volume output for several volume settings at different altitudes. Check the performance of the ventilator for adequate therapy delivery in the environment(s) in which it will be used and adjust the volume to compensate for altitude when necessary.



CAUTION

The actual volume output by the ventilator could be different from the calculated values shown.

Atmospheric Pressure			VOLUME SETTING ON LIFE2000® VENTILATION SYSTEM					
			90	150	250	350	500	750
Approximate Altitude			ML VOLUME OUTPUT					
HPA	FEET	METERS						
1100	-2290	-700	84	140	234	327	468	702
1075	-1640	-500	86	143	238	334	477	715
1050	-990	-300	87	146	243	340	486	729
1025	-320	-100	89	149	248	347	495	743
1000	370	110	91	152	253	354	505	758
975	1060	320	93	155	258	361	516	773
950	1770	540	95	158	263	369	527	790
925	2500	760	97	161	269	377	538	807
900	3240	990	99	165	275	385	550	826
875	4000	1220	101	169	282	394	563	845
850	4780	1460	104	173	288	404	577	865
825	5580	1700	106	177	295	413	591	886
800	6400	1950	109	182	303	424	606	908
775	7230	2200	112	186	310	435	621	931
750	8090	2470	115	191	319	447	638	957
725	8980	2740	118	197	328	459	656	984
700	9880	3010	121	202	337	472	675	1012
675	10820	3300	125	209	348	487	695	1043
650	11780	3590	129	215	358	501	716	1075
625	12780	3890	133	222	370	517	739	1109
600	13800	4210	138	229	382	535	765	1147

Performance specifications

The Life2000® Ventilator is classified per IEC 60601-1 as portable, Class II, Type BF, Drip-proof (IPX1), continuous operation.

The Life2000® Compressor is classified per IEC 60601-1 as portable, Class II, continuous operation.

PARAMETER	DESCRIPTION
General Information	
Available ventilation modes	Volume ventilation with Control, Assist/Control, and Assist ventilation modes
Connection to patient	Breathe Pillows Entrainment Interface or Universal Circuit® Connector
Features And Description	
Frequency	Ventilator can cycle at ≤ 40 BPM Accuracy: $\pm 10\%$ or 1 BPM, whichever is greater
Tidal Volume	Up to 2,000 ml
Volume output range	Range: 50 ml to 750 ml Resolution: 10 ml Accuracy: $\pm 15\%$ and ± 15 ml of set value, measured at ATP (ambient temperature and pressure)
Volume output settings	3 programmable Prescription Settings can provide different volume outputs as prescribed by the physician Each setting is clinician definable between 50 ml to 750 ml
Volume output adjustment	Volume output may be adjusted by patient as prescribed by physician using the available programmable prescription settings.
Inspiratory Time (I-Time)	Range: 0.15 sec to 3.00 sec Resolution: 0.05 sec Accuracy: ± 0.05 sec
Delivered peak gas flow rate from ventilator	8 LPM minimum 40 LPM maximum
Volume control	Closed loop proportional valve system
PEEP	Range: 0 to 10 cm H ₂ O (for software versions before 06.08.00.00) or 0–20 cm H ₂ O (for software versions 06.08.00.00 or newer). Resolution: 1 cmH ₂ O Accuracy: ± 2 cmH ₂ O
PIP Monitor ($P_{LIM\ max}$)	1 to 40 cmH ₂ O
Means of triggering	The breath delivery is triggered depending on the breath type—mandatory or assisted—and ventilation mode. The sensitivity setting, adjustable in increments of 1, ranges from 0 to 9, with 0 being the most sensitive and 9 being the least sensitive.
Inspiratory trigger delay time	Volume delivery is initiated based on the breath type and ventilation mode.
Available waveforms	Square waveform

PARAMETER	DESCRIPTION												
Means of initiating and terminating inspiratory phases	<p>Control ventilation mode: The inspiratory phase is started and terminated by the ventilator based on set inspiratory time and respiratory rate.</p> <p>Assist/Control ventilation mode: The inspiratory phase is started based on the patient's breath triggering or by the ventilator based on set inspiratory time and terminated by the set inspiratory time.</p> <p>Assist ventilation mode: The inspiratory phase is started based on the patient's breath triggering and terminated by the set inspiratory time.</p>												
Backup ventilation parameters	If a Breath Timeout alarm is triggered, the ventilator delivers the set volume at a continuous flow rate of 3 LPM or 12 BPM, preset by a clinician. When a patient's breath is detected again, the ventilator delivers the set volume based on Ventilation Settings parameters.												
Other Operating Requirements And Features													
Inspiratory pressure relief	Pressure is relieved through the patient's mouth or through the patient interface.												
Expiratory resistance at patient connection	<p>Breathe Pillows Entrainment Interface</p> <table border="0"> <tr> <td>Extra Small:</td> <td>1.9 cmH₂O at 30 LPM</td> <td>4.6 cmH₂O at 50 LPM</td> </tr> <tr> <td>Small:</td> <td>1.1 cmH₂O at 30 LPM</td> <td>3.5 cmH₂O at 50 LPM</td> </tr> <tr> <td>Medium:</td> <td>1.0 cmH₂O at 30 LPM</td> <td>3.3 cmH₂O at 50 LPM</td> </tr> <tr> <td>Large:</td> <td>0.96 cmH₂O at 30 LPM</td> <td>2.5 cmH₂O at 50 LPM</td> </tr> </table>	Extra Small:	1.9 cmH ₂ O at 30 LPM	4.6 cmH ₂ O at 50 LPM	Small:	1.1 cmH ₂ O at 30 LPM	3.5 cmH ₂ O at 50 LPM	Medium:	1.0 cmH ₂ O at 30 LPM	3.3 cmH ₂ O at 50 LPM	Large:	0.96 cmH ₂ O at 30 LPM	2.5 cmH ₂ O at 50 LPM
	Extra Small:	1.9 cmH ₂ O at 30 LPM	4.6 cmH ₂ O at 50 LPM										
Small:	1.1 cmH ₂ O at 30 LPM	3.5 cmH ₂ O at 50 LPM											
Medium:	1.0 cmH ₂ O at 30 LPM	3.3 cmH ₂ O at 50 LPM											
Large:	0.96 cmH ₂ O at 30 LPM	2.5 cmH ₂ O at 50 LPM											
Universal Circuit® Connector	0.4 cmH ₂ O at 30 LPM 1.6 cmH ₂ O at 60 LPM												
Inspiratory resistance at patient connection	<p>Breathe Pillows Entrainment Interface</p> <table border="0"> <tr> <td>Extra Small:</td> <td>2.4 cmH₂O at 30 LPM</td> </tr> <tr> <td>Small:</td> <td>1.3 cmH₂O at 30 LPM</td> </tr> <tr> <td>Medium:</td> <td>1.0 cmH₂O at 30 LPM</td> </tr> <tr> <td>Large:</td> <td>0.75 cmH₂O at 30 LPM</td> </tr> </table>	Extra Small:	2.4 cmH ₂ O at 30 LPM	Small:	1.3 cmH ₂ O at 30 LPM	Medium:	1.0 cmH ₂ O at 30 LPM	Large:	0.75 cmH ₂ O at 30 LPM				
	Extra Small:	2.4 cmH ₂ O at 30 LPM											
Small:	1.3 cmH ₂ O at 30 LPM												
Medium:	1.0 cmH ₂ O at 30 LPM												
Large:	0.75 cmH ₂ O at 30 LPM												
Universal Circuit® Connector	0.4 cmH ₂ O at 30 LPM												
Breath sensing line purge flow	A flow of gas is delivered through the sensing lumen to keep the sensing line patent.												
Fail safe mechanisms	Safety valve prevents overpressure condition in lung, mitigating breath stacking												
Alternate input pressure source requirements	<p>41 PSI to 87 PSI and ≥ 40 LPM flow continuous output at 41 PSI</p> <p>Compatible sources:</p> <ul style="list-style-type: none"> • Regulated medical grade oxygen gas cylinders • Medical grade oxygen wall sources • Any other medical grade oxygen sources meeting the above criteria 												
Range, resolution, and accuracy of respiratory rate monitor	<p>Range: 1 BPM to 120 BPM</p> <p>Resolution: 1 BPM</p> <p>Accuracy: ±10% or 1 BPM, whichever is greater, up to 50 BPM</p>												

PARAMETER	DESCRIPTION
Range, resolution, and accuracy of air or oxygen minute volume display	<p>Range: 0 LPM to 20 LPM. Resolution: 0.1 LPM. Accuracy: $\pm 10\%$ or $\pm(10 \text{ ml} \times \text{average breath rate})$, whichever is greater.</p> <p> NOTE: The displayed air or oxygen minute volume is the product of the average breath rate times the average measured air or oxygen volume settings. During continuous delivery, the ventilator displays an air or oxygen minute volume of 3.0 LPM.</p>
Oxygen source time (stationary oxygen)	Indefinite
Usage types	<p>Stationary use: Place on table or flat surface. Extended Range use with oxygen hose. Stand-Alone use with cylinder or alternate gas source.</p>
Ventilator Battery Specifications	
Type	Lithium ion, rechargeable, not user replaceable.
Ampere/hour rating	1800 mAh
Maximum current	450 mA
Operating Voltage	7.4 V internal
Duration	Approximately 4 hours
If the battery performance degrades to unacceptable levels contact your service representative.	
Compressor Battery Specifications	
Type	Lithium ion, rechargeable, not user replaceable.
Ampere/hour rating	10200 mAh
Maximum current	10 A
Operating Voltage	28.8 V internal
Duration	1 hour
If the battery performance degrades to unacceptable levels contact your service representative.	
Special Features	
Alarm vibrate	Instead of an audio alarm, the user can enable the alarm to vibrate for medium- and low-level alarms.
Touch screen flip	User can flip the screen orientation 180°.
Universal Circuit® Connector	Used to connect commercially available non-invasive masks (full face, nasal, and pillows) or tracheostomy tubes for invasive ventilation
Acoustic levels during normal operation	
Compressor	≤ 60 dBA at a distance of 1 meter
Ventilator Alarm Notifications	
High Priority Alarm	<p>At Maximum loudness setting: 73 db(A) At Minimum loudness setting: 60 db(A)</p>

Medium Priority Alarm	At Maximum loudness setting: 72 db(A) At Minimum loudness setting: 59 db(A)
PARAMETER	DESCRIPTION
Ventilator Alarms	
High Circuit Pressure	Interface may be pinched or kinked.
High PEEP Pressure	Interface may be blocked.
High PIP Pressure	Peak Inspiratory Pressure (PIP) exceeds the set limit.
High Temperature	Ventilator CPU or battery temperature is above the allowable limit.
Very Low Battery	Ventilator battery capacity drops below 15%.
Battery Low	Ventilator battery capacity drops below 25%.
Breath Timeout	No breath is detected for 20 seconds or 60 seconds, depending on the setting.
High Breath Rate	Respiratory rate exceeds the set limit.
High Delivery Pressure	Interface pressure during delivery exceeds the maximum expected.
High Gas Pressure	Source gas pressure exceeds the allowable limit (95 PSI).
Low Breath Rate	Respiratory rate falls below the set limit.
Low Delivery Pressure	Interface pressure during delivery fails to exceed the minimum expected.
Low Gas Pressure	Source gas pressure drops below the allowable limit (20 PSI) High Priority Alarm
Low Gas Pressure	Source gas pressure drops below the allowable limit (35 PSI) Medium Priority Alarm.
Low PIP Pressure	PIP below set limit
System Fault	Internal fault detected during operation.
Excessive Leak	An excessive leak is present
POST System Fault	System fault detected during ventilator power on.
Sensor Fault	Sensor Fault detected during use of ventilator.
Monitors and Indicators	
Ventilator user interface	Touch screen LCD for settings, monitors, and alarms. Mechanical buttons for on/off, alarm silence, and prescription settings
Pressure monitoring	Ventilator output pressure and airway pressure are monitored continuously. Airway pressure is monitored using a lumen in the gas delivery circuit wall, which terminates in a sensing port on the distal end of the circuit.
Volume Setting displays	1. Delivered volume setting is displayed.
Ventilator breath indicator	An LED visual indicator indicating an inspiration.
Compressor battery indicator	When the compressor is powered on, the internal battery level is displayed using indicator lights in the battery charge scale. An alarm occurs when battery capacity is 20% or less.
Ventilator battery indicator	Indicates percentage of battery charge remaining. Always displayed on touch screen. Alarm occurs when capacity is below 25% and again at 15%.

Standards and Regulatory Compliance	
AAMI/ANSI 60601-1:2005, ANSI/AAMI HE75:2009, AIM 7351731, ASTM F1246-91 (2005), IEC 60601-1-2:2007, IEC 62133:2012 (2nd edition), IEC 62366:2007, ISO 10993-1:2009, ISO 80601-2-12:2011, ISO 80601-2-72:2015	
PARAMETER	DESCRIPTION
Ventilator AC Battery Charger Specifications	
Input AC voltage	100-240 VAC
Input AC frequency	50-60 Hz
Input AC current	0.3 A max.
Output DC voltage	8.4 VDC
Output DC current	1.3 A
Insulation class	Class II
Electrical safety approvals	UL 60601-1, EN 60950, EN 60601-1, EN 60335-2-29
Dimensions	3.55" x 1.77" x 1.26" (90 x 45 x 32 mm)
Weight	0.25 lb.. (115 g)
Ventilator Power Cord Specifications	
Cord length	6 ft.
Compliance	IEC 320-E7
Compressor Power Supply Specifications	
Input AC voltage	100-240 VAC
Input AC frequency	50-60 Hz
Input AC current	5 A max. at 100 VAC 2.5 A max. at 240 VAC
Output DC voltage	24 VDC
Output DC current	12.5 A
Insulation class	Class II
Ingress protection rating	IP22
Electrical safety approvals	IEC 60601-1, IEC 60601-1-11
Dimensions	7.8" x 4" x 2" (198 x 102 x 51 mm)
Weight	3 lb. (1.36 kg)
Compressor Power Cord Specifications	
Cord length	6 ft.
Compliance	IEC 320-C13
Compressor Output	
Pressure	58 PSI \pm 15% (at sea level and normal ambient conditions)
Flow	17–21 LPM (at sea level and normal ambient conditions)
Outlet Fitting	9/16" - 18 male threaded fitting

PARAMETER	DESCRIPTION										
Storage and Transport Environment											
Storage & Transport Temperature	-20°C to +60°C (-4°F to +140°F)										
Storage & Transport Humidity	10% to 95% non-condensing										
Storage & Transport Altitude	1100 hPa to 624 hPa or -2290 ft. to +8000 ft. (-700 m to +2439 m)										
Operating Environment											
Operating Temperature	+5°C to +40°C (+41°F to +104°F)										
Operating Humidity	15% to 90% non-condensing										
Operating Altitude	1100 hPa to 624 hPa or -2290 ft to +8000 ft (-700 m to +2439 m)										
 NOTES <ul style="list-style-type: none"> The performance of the compressor may degrade in high temperature, high humidity, or high altitude environments. If degradation is seen, switch to an alternate means of ventilation. The ventilator settings might not be achieved when sourced by the Life2000® Compressor due to increases in altitude near or above 2500 feet. Consult the table to ensure that the compressor can meet the ventilator settings. The tidal volume delivered to the patient includes the ventilator set volume + entrainment volume from patient interface + supplemental oxygen volume (if used). For additional information see page 159. 											
	<table border="1"> <thead> <tr> <th>Simulated Elevation (in feet)</th> <th>Observed Maximum Compressor Output (in LPM)</th> </tr> </thead> <tbody> <tr> <td>0</td> <td>17</td> </tr> <tr> <td>2500</td> <td>14</td> </tr> <tr> <td>4000</td> <td>12</td> </tr> <tr> <td>8000</td> <td>8</td> </tr> </tbody> </table>	Simulated Elevation (in feet)	Observed Maximum Compressor Output (in LPM)	0	17	2500	14	4000	12	8000	8
Simulated Elevation (in feet)	Observed Maximum Compressor Output (in LPM)										
0	17										
2500	14										
4000	12										
8000	8										
Physical Features											
Ventilation system weight	16 lb.										
Ventilation system size	12.1" x 8.7" x 8.6"										
Ventilator weight	1.1 lb.										
Ventilator size	3.2" x 7.7" x 1.0"										
Compressor weight	14.9 lb.										
Compressor size	12.1" x 8.7" x 8.6"										
Latex	The ventilation system does not contain natural rubber latex.										
Expected Service Life											
Expected Service Life	<p>The Life2000® Ventilation System has a five year design life when operated in accordance with the Instructions For Use provided.</p> <p>Do not use the ventilation system past its expected service date.</p> <p>The battery shall be replaced if performance degrades to an unacceptable level during the one year warranty period.</p>										
Service Intervals											
Service Intervals	1 year and 2.5 years from the date of shipment										

Principles of operation

General overview

The Life2000® Ventilation System utilizes an electromechanical pneumatic system under the control of a microprocessor to deliver patient ventilation. The following descriptions and diagrams illustrate the major components of the ventilation system in each configuration.

Stationary configuration operation summary and pneumatic diagram

Ambient air enters through an inlet filter on the compressor. The compressor pressurizes the air and then delivers it to the ventilator. In the ventilator, the air flows through the safety valve and then to the flow valve, which controls all inspiratory air flow to the patient. A flow sensor is also provided to measure delivered flow to the patient, and the closed-loop control system ensures the delivery of the required flow to the patient. A pressure sensor is also used to measure the pressure at the patient connection to ensure patient safety. The electromechanical pneumatic system also controls PEEP during exhalation.

Stationary configuration

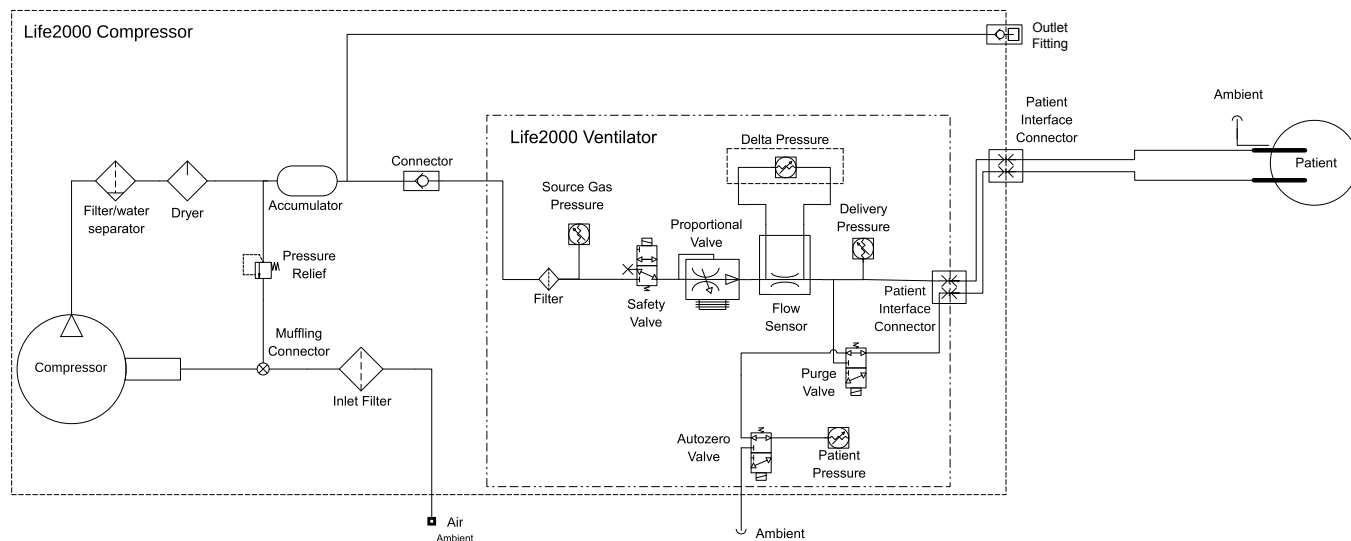

Extended Range configuration operation summary and pneumatic diagram

Ambient air enters through an inlet filter on the compressor. The compressor pressurizes the air and then delivers it to the ventilator through a source gas supply hose.

In the ventilator, the gas flows through the safety valve and then to the flow valve, which controls all inspiratory air flow to the patient. A flow sensor is provided to measure delivered flow to the patient, and the closed-loop control system ensures the delivery of the required flow to the patient. A pressure sensor is used to measure the pressure at the patient connection to ensure patient safety. The electromechanical pneumatic system controls PEEP during exhalation.

Extended Range configuration

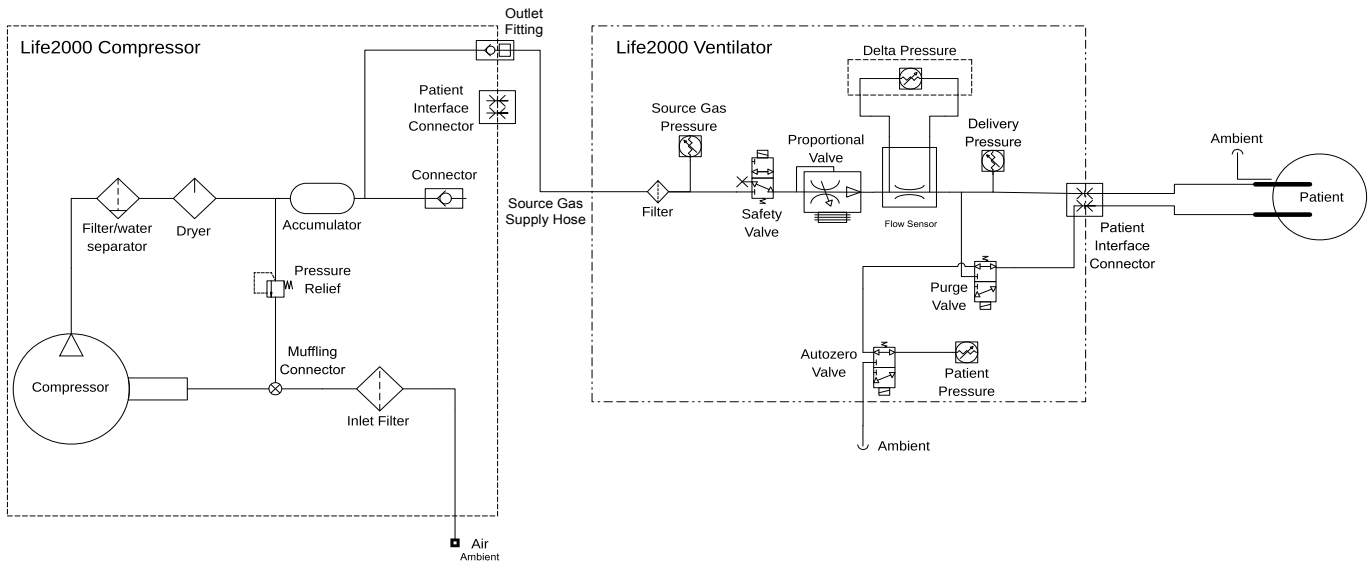

Stand-Alone configuration operation summary and pneumatic diagram

Compressed gas (oxygen or air) enters the ventilator through the inlet connector. The compressed gas is delivered to the safety valve and then to the flow valve, which controls all inspiratory gas flow to the patient. A flow sensor is provided to measure delivered flow to the patient, and the closed-loop control system ensures the delivery of the required flow to the patient. A pressure sensor is used to measure the pressure at the patient connection to ensure patient safety. The electromechanical pneumatic system controls PEEP during exhalation.

Stand-Alone configuration

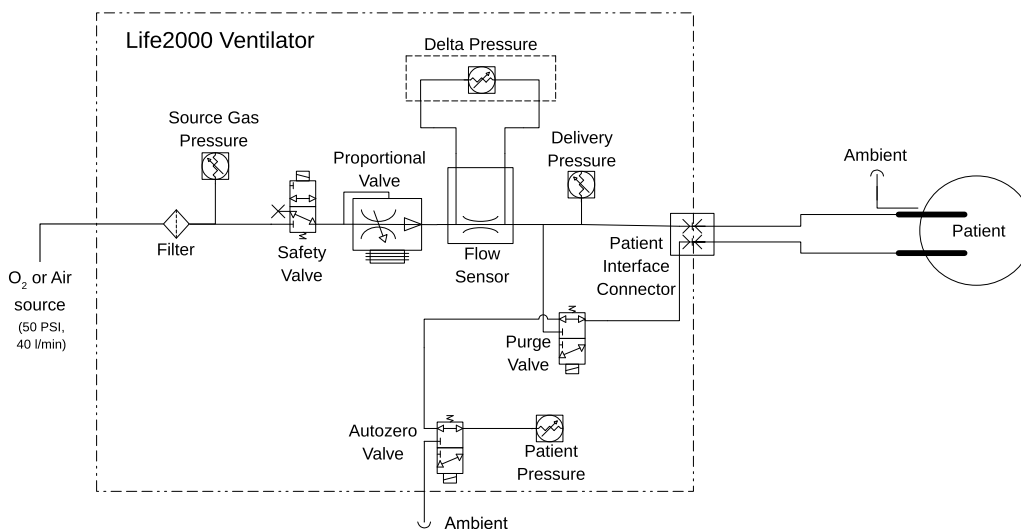

Compliance IEC classification

IEC COMPLIANCE: EN/IEC 60601-1-2 4th edition: 2014 (Medical electrical equipment Part 1-2: General requirements for basic safety and essential requirements - Collateral standard: Electromagnetic disturbances - Requirements and tests) defines the RF emissions limits and minimum RF immunity requirements for different types of medical electrical equipment. The following tables include the RF emissions limits and RF immunity requirements for, and results of tests upon, the Life2000® Ventilation System.

The Life2000® Ventilation System requires special precautions regarding electromagnetic compatibility (EMC) and needs to be installed and put into service according to the EMC information provided in this Instructions for use.

The use of accessories or cables other than those specified may result in increased emissions or decreased immunity of the Life2000® Ventilation System.

GUIDANCE AND MANUFACTURER'S DECLARATION: ELECTROMAGNETIC EMISSIONS		
The Life2000® Ventilation System is intended for use in the electromagnetic environment specified below. The customer or user of the ventilation system should ensure that it is used in such an environment.		
Emission Test	Compliance	Electromagnetic Environment - Guidance
RF emissions CISPR 11	Group 1	The Life2000® Ventilation System RF emissions are within CISPR 11 guidelines and are not likely to cause interference in nearby electronic equipment. The Life2000® Ventilation System is suitable for use in all establishments, including domestic establishments and those directly connected to the public power supply network that supplies buildings used for domestic purposes.
RF emissions CISPR 11	Class B	
Harmonic emissions IEC 61000-3-2	Complies	
Voltage fluctuations/flicker emissions IEC 61000-3-3	Complies	

GUIDANCE AND MANUFACTURER'S DECLARATION: ELECTROMAGNETIC IMMUNITY

The Life2000® Ventilation System is intended for use in the electromagnetic environment specified below. The customer or user of the ventilation system should ensure that it is used in such an environment.

Immunity Test	IEC 60601 Requirement	Compliance Level	Electromagnetic Environment - Guidance
Electrostatic discharge (ESD) IEC 61000-4-2	±8 kV contact ±15 kV air	±8 kV contact ±15 kV air	Floors should be wood, concrete or ceramic tile. If floors are covered with synthetic material, the relative humidity should be at least 30%.
Electrical fast Transient/burst IEC 61000-4-4	±2 kV for power supply lines ±1 kV for input/output lines	±2 kV for power supply lines Not applicable	Mains power quality should be that of a typical household or hospital environment.
Surge IEC 61000-4-5	±1 kV line(s) to line(s) ±2 kV line(s) to earth	±1 kV line(s) to line(s) ±2 kV line(s) to earth	Mains power quality should be that of a typical household or hospital environment.
Voltage dips, short interruptions and voltage variations on power supply input lines IEC 61000-4-11 ¹	0% U_T (95% dip in U_T for 0.5 cycle)	0% U_T ; 0.5 cycle, at 0°, 45°, 90°, 135°, 180°, 225°, 270°, and 315°	Mains power quality should be that of a typical household or hospital environment.
	0% U_T ; 1 cycle	0% U_T ; 1 cycle	
	70% U_T (30% dip in U_T for 25 cycles)	70% U_T ; 25/30 cycles	
	0% U_T for 5 seconds	0% U_T ; 250/300 cycles	
Power frequency (50/60 Hz) magnetic field IEC 61000-4-8	30 A/m	30 A/m	Power frequency magnetic fields should be at levels characteristic of a typical location in a typical household or hospital environment.

GUIDANCE AND MANUFACTURER'S DECLARATION: ELECTROMAGNETIC IMMUNITY

The Life2000® Ventilation System is intended for use in the electromagnetic environment specified below. The customer or user of the ventilation system should ensure that it is used in such an environment.

LIFE2000® VENTILATION SYSTEM

Immunity Test	IEC 60601 Requirement	Compliance Level	Electromagnetic Environment - Guidance
Conducted RF IEC 61000-4-6	3 Vrms 150 kHz to 80 MHz, 6 Vrms in ISM and amateur radio band between 0.15 MHz and 80 MHz, 80% modulation at 1 KHz	3 Vrms 150 kHz to 80 MHz, 6 Vrms in ISM and amateur radio band between 0.15 MHz and 80 MHz, 80% modulation at 1 KHz	Portable and mobile RF communications equipment should be used no closer to any part of the Life2000® Ventilation System, including cables, than the recommended separations distance calculated from the equation applicable to the frequency of the transmitter. ² Recommended separation distance: ³ $d = 1.17 \sqrt{P}$ 150 kHz to 80MHz $d = 0.35 \sqrt{P}$ 80 MHz to 800 MHz ³ $d = 0.70 \sqrt{P}$ 800 MHz to 2.5GHz
Radiated RF IEC 61000-4-3	Shall withstand test frequencies, amplitudes, and conditions specified in Table 9 of IEC 60601-1-2 (4th ed.)	Tested to frequencies, amplitudes, and conditions specified in Table 9 of IEC 60601-1-2 (4th ed.)	Where P is the maximum output power rating of the transmitter in watts (W) according to the transmitter manufacturer and d is the recommended separation distance in meters (m). Field strengths from fixed RF transmitters, as determined by an electromagnetic site survey* should be less than the compliance level in each frequency range. Interference may occur in the vicinity of equipment marked with the following symbol: 



NOTE 1: U_T is the AC mains voltage prior to application of the test level.



NOTE 2: These guidelines may not apply in all situations. Electromagnetic propagation is affected by absorption and reflection from structures, objects and people.



NOTE 3: At 80 MHz and 800 MHz, the higher frequency range applies.

* Field strengths from fixed transmitters, such as base stations for radio (cellular/cordless) telephones and land mobile radios, amateur radio, AM and FM radio broadcast and TB broadcast cannot be predicted theoretically with accuracy. To assess the electromagnetic environment due to fixed RF transmitters, and electromagnetic site survey should be considered. If the measured field strength in the location in which the ventilation system is used exceeds the applicable RF compliance level above, the ventilation system should be observed to verify normal operation. If abnormal performance is observed, additional measures may be necessary, such as reorienting or relocating the ventilation system.

RECOMMENDED SEPARATION DISTANCES BETWEEN PORTABLE AND MOBILE RF COMMUNICATION EQUIPMENT AND THE LIFE2000® VENTILATION SYSTEM

The Life2000® Ventilation System is intended for use in an electromagnetic environment in which radiated RF disturbances are controlled. The clinician can help prevent electromagnetic interferences by maintaining a minimum distance between portable and mobile RF communications equipment (transmitters) and the ventilation system as recommended in this table, according to the maximum output power of the communications equipment.¹

Rated maximum output power of transmitter (W)	Separation distance according to frequency of transmitter (m)		
	150 kHz to 80 MHz $d = 1.17 \sqrt{P}$	80 MHz to 800 MHz ² $d = 0.35 \sqrt{P}$	800 MHz to 2.5 GHz $d = 0.7 \sqrt{P}$
0.01	0.17	0.035	0.070
0.1	0.37	0.11	0.22
1	1.17	0.35	0.70
10	3.69	1.1	2.2
100	11.70	3.5	7.0















NOTE 1: These guidelines may not apply in all situations. Electromagnetic propagation is affected by absorption and reflection from structures, objects and people.







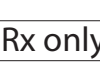

















NOTE 2: At 80 MHz and 800 MHz, the separation distance for the higher frequency range applies.









For transmitters rated at a maximum output power not listed above, the recommended separations distance (d) in meters (m) can be estimated using the equations given in the table above applicable to the frequency of the transmitter, where P is the maximum output power rating of the transmitter in watts (W) according to the transmitter manufacturer.

Icons

ICON	WHERE USED	MEANING
	Ventilator	Indicates communication port. This port is only used by the manufacturer.
	Ventilator	Indicates power-in port.
	Ventilator and compressor	Indicates direct current.
	Ventilator, ventilator label, and compressor label	The Silence Alarm button silences a vibration or audible alarm for 60 seconds.
	Ventilator touch screen	Displayed in the Active Alarms window of the touch screen if an active alarm has not been silenced.
	Ventilator touch screen	Displayed in the Active Alarms window of the touch screen if an active alarm has been silenced. Displayed on the bottom of touch screen if all active alarms have been silenced.
	Ventilator touch screen	Displayed on touch screen. Touching the Wrench button displays the Menu screen.
	Ventilator touch screen	Displayed on touch screen. Touching the Flip button rotates the touch screen 180°.
	Ventilator touch screen	Displayed on touch screen if ventilator is in vibrate mode.
	Ventilator label and compressor label	Indicates catalog number and denotes the location of the part number
	Ventilator label and compressor label	Indicates serial number and denotes the location of the serial number
	Ventilator label	Alternative to the prescription device labeling statement "Caution: Federal law restricts this device to sale by or on the order of a physician."
	Purge tube connector label, purge tube label, pole mount label, source gas supply hose label, and interface labels	Indicates that the product is not sterile.

ICON	WHERE USED	MEANING
	Ventilator touch screen	Displayed on touch screen if ventilator battery status is unknown or charge is critically low (< 5%).
	Ventilator touch screen	Displayed on touch screen if ventilator battery has approximately 5-14% of its charge remaining.
	Ventilator touch screen	Displayed on touch screen if ventilator battery has approximately 15–35% of its charge remaining.
	Ventilator touch screen	Displayed on touch screen if ventilator battery has approximately 36–56% of its charge remaining.
	Ventilator touch screen	Displayed on touch screen if ventilator battery has approximately 57–84% of its charge remaining.
	Ventilator touch screen	Displayed on touch screen if ventilator battery charge has approximately 85–100% of its charge remaining.
	Ventilator touch screen	Displayed on touch screen if battery is charging.
	Ventilator label and compressor label	Indicates BF type equipment. Device isolates the patient from any live voltage in the equipment.
	Ventilator label, compressor label, ventilator battery charger label, and compressor external power supply	Indicates a Class II device. Device is double insulated and does not require a safety connection to electrical earth (US: ground).
	Ventilator label and compressor label	Consult Instructions for Use.
	Ventilator label and compressor label	Indicates that the device poses unacceptable risks within the magnetic resonance (MR) environment.
	Ventilator label and compressor label	Keep dry. Indicates that the device needs to be protected from moisture.

ICON	WHERE USED	MEANING
	Ventilator label, compressor label, compressor external power supply	Indicates disposal of device must conform to WEEE Directive (Waste in Electrical and Electronic Equipment) 2011/65/EU.
	Ventilator battery charger label	This symbol is used to support the Battery Directive 2006/66/EC.
	Ventilator battery charger label and compressor external power supply	Indicates the battery charger meets European Economic Area standards for use.
	Ventilator label and compressor label	Indicates manufacturer and denotes manufacturer name and address.
	Ventilator battery charger label and compressor external power supply	Indicates product meets US standards for use with medical electrical equipment.
	Ventilator battery charger label	Consult Instructions for Use.
	Ventilator label, compressor label, and documentation	Documentation includes important information that must be read before using device.
	Ventilator battery charger label	Indicates indoor use only and denotes that it should only be used indoors
	Ventilator battery charger label	Indicates battery charge. The black shaded area represents the amount of charge within the battery.
	Compressor external power supply	Certifies that the electromagnetic interference from the device is under limits approved by the Federal Communications Commission
	Compressor external power supply	Indicates compliance with the latest DOE Efficiency Level VI requirements for average efficiency and standby power

ICON	WHERE USED	MEANING
	Compressor external power supply	Indicates compliance with RoHS.
	Compressor	Indicates the locking knob is in the unlocked position.
	Compressor	When lit, indicates the locking knob is in the locked position.
	Compressor	Battery Charge Status button
	Compressor	Power on/off button
	Ventilator	Power on/off button
	Ventilator and ventilator touch screen	<p>On the ventilator, the Low Activity Button delivers prescription parameters set by a clinician in the Clinician's Settings menu.</p> <p>Displayed on the Prescription Settings screen as a label for the Low Activity Prescription Setting parameters set by a clinician.</p> <p>Displayed on the touch screen if the ventilator is set to the Low Activity Prescription Setting.</p>
	Ventilator and ventilator touch screen	<p>On the ventilator, the Medium Activity Button delivers prescription parameters set by a clinician in the Clinician's Settings menu.</p> <p>Displayed on the Prescription Settings screen as a label for the Medium Activity Prescription Setting parameters set by a clinician.</p> <p>Displayed on the touch screen if the ventilator is set to the Medium Activity Prescription Setting.</p>
	Ventilator and ventilator touch screen	<p>On the ventilator, the High Activity Button delivers prescription parameters set by a clinician in the Clinician's Settings menu.</p> <p>Displayed on the Prescription Settings screen as a label for the High Activity Prescription Setting parameters set by a clinician.</p> <p>Displayed on the touch screen if the ventilator is set to the High Activity Prescription Setting.</p>

Appendix

Accessories and Replacement Parts



WARNING

For any accessories, read the label and accompanying document(s) before use.

PART NUMBER	PRODUCT DESCRIPTION
Interfaces (for single patient use only)	
BT-60-0010	Universal Circuit® Connector
BT-60-0013	Breathe Pillows Entrainment Interface™, Extra Small
BT-60-0014	Breathe Pillows Entrainment Interface™, Small
BT-60-0015	Breathe Pillows Entrainment Interface™, Medium
BT-60-0016	Breathe Pillows Entrainment Interface™, Large
Source Gas Supply Hoses	
BT-55-0003	Oxygen Hose, 6 ft.
BT-55-0004	Oxygen Hose, 10 ft.
BT-55-0005	Oxygen Hose, 20 ft.
BT-55-0033	CombO ₂ ® Hose, 10 ft.
BT-55-0034	CombO ₂ ® Hose, 20 ft.
BT-55-0035	CombO ₂ ® Hose, 50 ft.
Power Supply and Charger	
MS-03-1506	Compressor External Power Supply
MS-03-1511	Compressor AC Power Cord
MS-02-0180	Ventilator Battery Charger
MS-03-0019	Ventilator Charger AC Cord
Cleaning and Purging	
BT-80-0005	Life2000® Compressor Filter Package (includes one cooling filter assembly, and one condensation tray)
MS-03-1597	Purge Tube Connector
BT-00-0001	Purge Tube
Other	
MS-03-0772	Ventilator Belt Clip
BT-00-0017	Ventilator Pole Mount
BT-55-0031	Ventilator Carry Case and 7.5 ft. Belt

Cylinder Duration Information

The duration of compressed medical oxygen cylinders depends on the volume of the cylinder and the breathing pattern of each patient, which can change throughout the day. Observe your daily oxygen consumption a few times before estimating typical use. The following tables can be used to obtain approximate values only.



NOTE

These tables use a PEEP value of 0 cmH₂O.

Cylinder size B: 164 liters (M6)

	BREATHS PER MINUTE (BPM)								
	12	14	16	18	20	22	24	26	28
Volume (ml)	Duration in hours								
50	4.6	3.9	3.4	3.0	2.7	2.5	2.3	2.1	2.0
100	2.3	2.0	1.7	1.5	1.4	1.2	1.1	1.1	1.0
150	1.5	1.3	1.1	1.0	0.9	0.8	0.8	0.7	0.7
200	1.1	1.0	0.9	0.8	0.7	0.6	0.6	0.5	0.5
250	0.9	0.8	0.7	0.6	0.5	0.5	0.5	0.4	0.4
500	0.5	0.4	0.3	0.3	0.3	0.2	0.2	0.2	0.2
750	0.3	0.3	0.2	0.2	0.2	0.2	0.2	0.1	0.1

Cylinder size D: 425 liters (M15)

	BREATHS PER MINUTE (BPM)								
	12	14	16	18	20	22	24	26	28
Volume (ml)	Duration in hours								
50	11.8	10.1	8.9	7.9	7.1	6.4	5.9	5.4	5.1
100	5.9	5.1	4.4	3.9	3.5	3.2	3.0	2.7	2.5
150	3.9	3.4	3.0	2.6	2.4	2.1	2.0	1.8	1.7
200	3.0	2.5	2.2	2.0	1.8	1.6	1.5	1.4	1.3
250	2.4	2.0	1.8	1.6	1.4	1.3	1.2	1.1	1.0
500	1.2	1.0	0.9	0.8	0.7	0.6	0.6	0.5	0.5
750	0.8	0.7	0.6	0.5	0.5	0.4	0.4	0.4	0.3

Cylinder size E: 660 liters (M24)

	BREATHS PER MINUTE (BPM)								
	12	14	16	18	20	22	24	26	28
Volume (ml)	Duration in hours								
50	18.3	15.7	13.8	12.2	11.0	10.0	9.2	8.5	7.9
100	9.2	7.9	6.9	6.1	5.5	5.0	4.6	4.2	3.9
150	6.1	5.2	4.6	4.1	3.7	3.3	3.1	2.8	2.6
200	4.6	3.9	3.4	3.1	2.8	2.5	2.3	2.1	2.0
250	3.7	3.1	2.8	2.4	2.2	2.0	1.8	1.7	1.6
500	1.8	1.6	1.4	1.2	1.1	1.0	0.9	0.8	0.8
750	1.2	1.0	0.9	0.8	0.7	0.7	0.6	0.6	0.5

Oxygen usage (LPM) Table

For other cylinder sizes, use the following gas usage chart to estimate your cylinder duration.

Volume (ml)	BREATHS PER MINUTE (BPM)								
	12	14	16	18	20	22	24	26	28
	Oxygen Usage (LPM)								
50	0.6	0.7	0.8	0.9	1.0	1.1	1.2	1.3	1.4
100	1.2	1.4	1.6	1.8	2.0	2.2	2.4	2.6	2.8
150	1.8	2.1	2.4	2.7	3.0	3.3	3.6	3.9	4.2
200	2.4	2.8	3.2	3.6	4.0	4.4	4.8	5.2	5.6
250	3.0	3.5	4.0	4.5	5.0	5.5	6.0	6.5	7.0
500	6.0	7.0	8.0	9.0	10.0	11.0	12.0	13.0	14.0
750	9.0	10.5	12.0	13.5	15.0	16.5	18.0	19.5	21.0



NOTE

This table uses a PEEP value of 0 cmH₂O.

Cylinder Duration Equation

For other cylinder sizes or partially-filled cylinders, the following equation can be used in conjunction with the above oxygen usage table to estimate cylinder duration.

$$\text{cylinder duration} = \frac{\left(\frac{P_T V_T}{14.7} \right)}{\text{gas usage}}$$

Where:

P_T = cylinder pressure (typically 2200 PSI for full cylinder)

V_T = empty cylinder volume (4.5L for an E cylinder).

Replacing the Source Gas Cylinder

When the source gas cylinder needs to be replaced:

- 1 Place the patient on an alternate means of ventilation, if necessary.
- 2 Power off the ventilator.



NOTE

Alarms might be encountered and/or the selected Activity Button might be inadvertently changed if the ventilator is not powered off before replacing the cylinder.

- 3 Turn off the oxygen supply according to the regulator and gas supply manufacturers' instructions.
- 4 Remove the regulator and attached source gas supply hose from the used cylinder by turning the handle counterclockwise.
- 5 Slide the regulator over the neck of the new cylinder, and line up the pins on the regulator with the holes in the cylinder neck. Tighten the tee screw on the regulator by turning the handle clockwise. (The source gas supply hose should still be connected to the regulator.)
- 6 Turn on the oxygen supply according to the regulator and gas supply manufacturers' instructions.
- 7 Power on the ventilator.



NOTE

Ventilation will not begin until an Activity Button is selected. For more information see "Choosing an activity button (Patient selectable) to begin ventilation" on page 65.

Potential Tidal Volumes

The potential tidal volumes for the corresponding set volumes on the Life2000® Ventilator are shown in the following graph. The graph can be used to obtain approximate values only.

The potential patient volume per breath is a combination of ventilator settings (Volume and I-Time) plus the amount of room air entrained to the patient interface plus the amount of supplemental oxygen (if any) that is injected into the patient interface. It is further influenced by the patient's resistance, compliance and effort. As a result, the potential patient volume will be higher than the ventilator set volume.



NOTE

This graph uses a PEEP value of 0 cmH₂O.

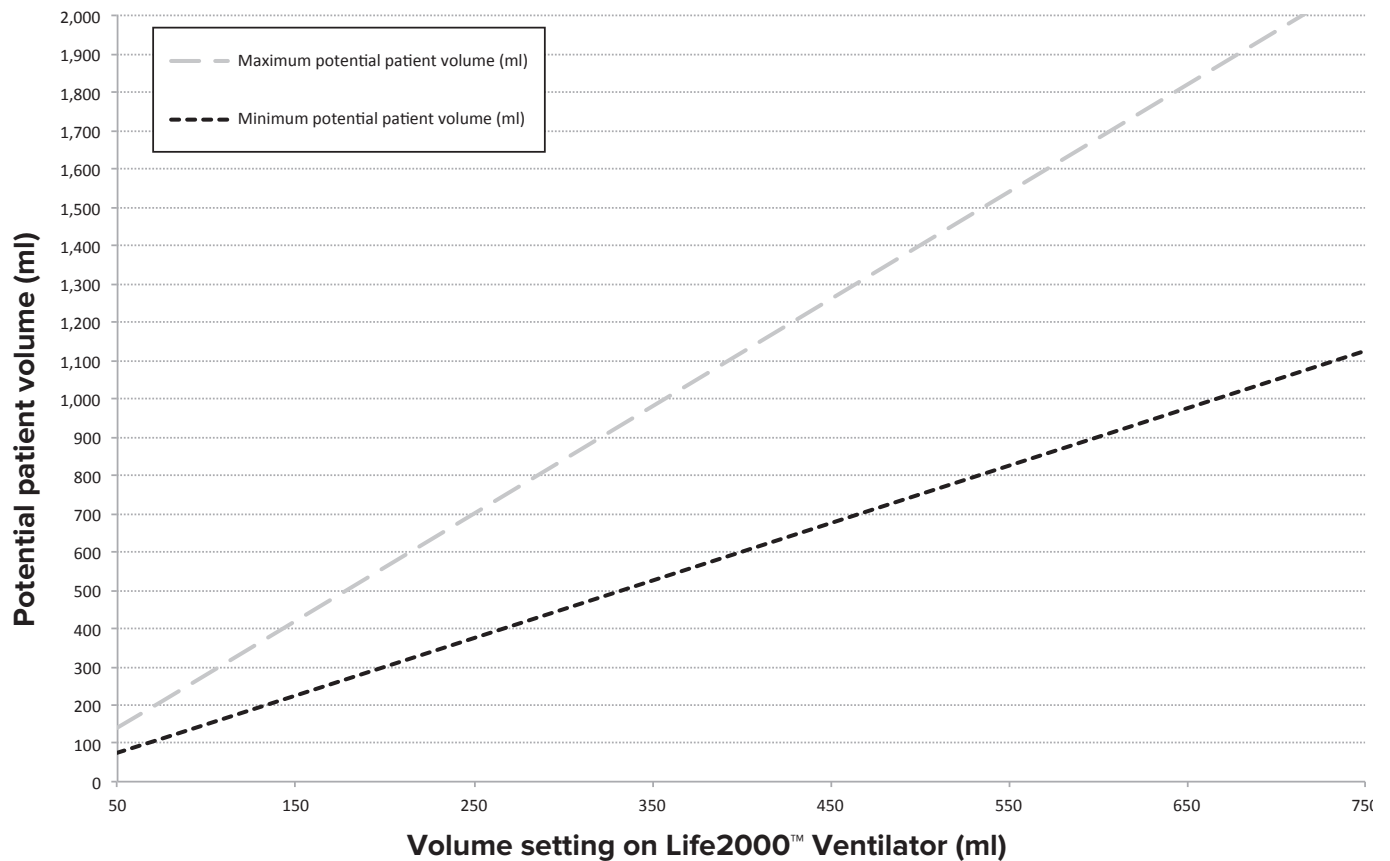

FiO2 Tables

Universal Circuit® Connector using air as the pressure source*

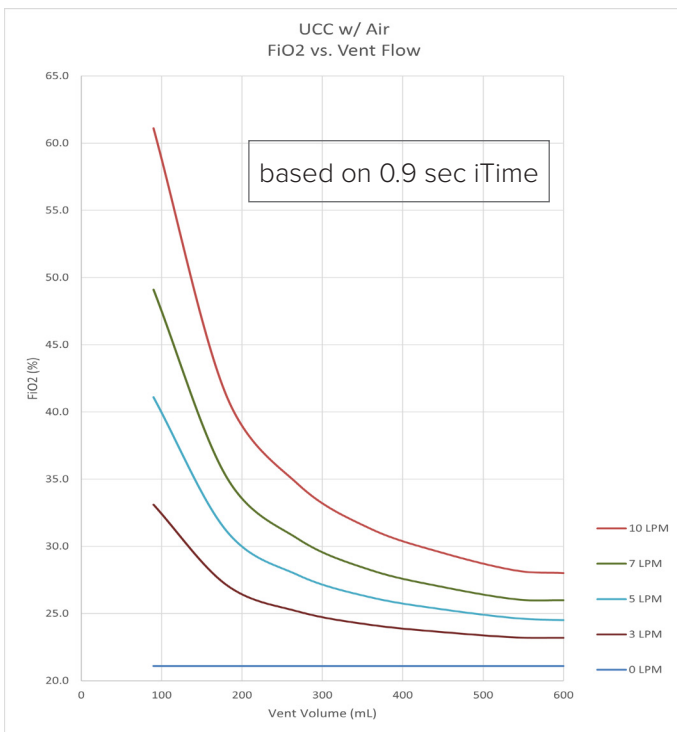

* entrained with supplemental oxygen in the volumes (LPM) shown

Universal Circuit® Connector using oxygen as the pressure source*

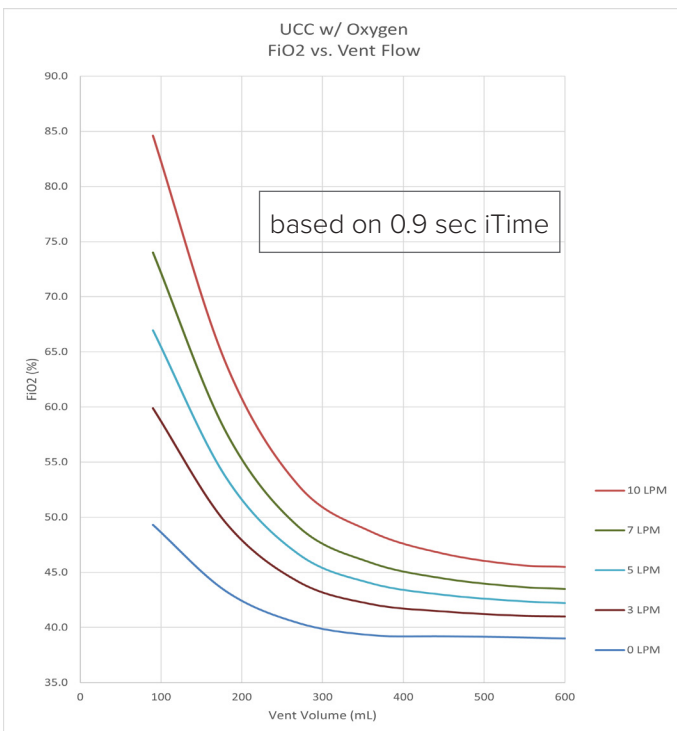

* entrained with supplemental oxygen in the volumes (LPM) shown

Breathe Pillows Entrainment Interface using air as the pressure source*

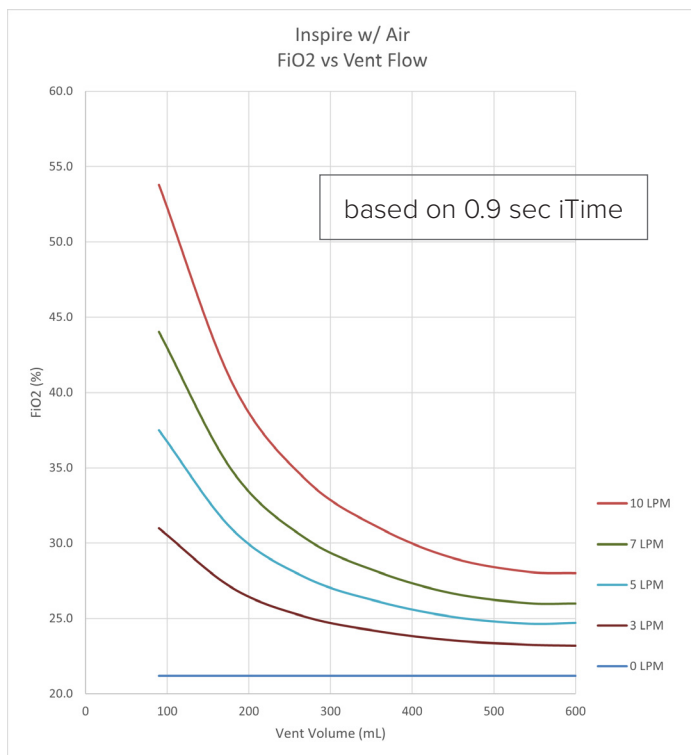

* entrained with supplemental oxygen in the volumes (LPM) shown

Breathe Pillows Entrainment Interface using oxygen as the pressure source*

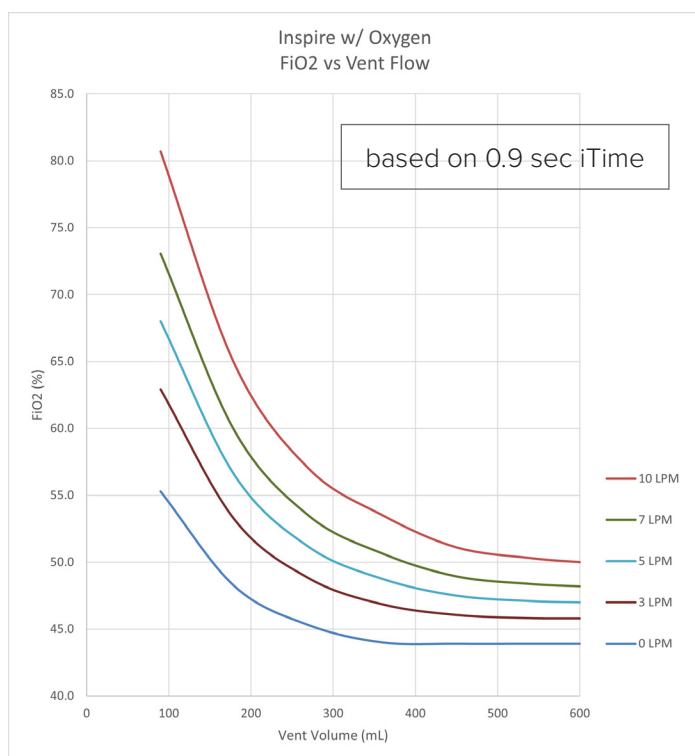

* entrained with supplemental oxygen in the volumes (LPM) shown

Limited Warranty

Breathe Technologies, Inc., a Hillrom_™ Company, warrants that the Life2000[®] ventilators and compressors will be free from defects in material and workmanship for a period of one (1) year from the date of shipment. Products that are repaired or replaced under this Limited Warranty will be covered by this Limited Warranty for the greater of the remaining balance of the original warranty or ninety (90) days.

Patient interfaces and accessories manufactured by Breathe Technologies are warranted for thirty (30) days from date of shipment.

Accessories and replacement parts manufactured by third parties and used with Breathe Technologies ventilators, including, but not limited to regulators, are not covered under this warranty.

This limited warranty shall only extend to the original end user of the product purchased. This limited warranty may not be assigned or transferred.

Warranty service

Breathe Technologies, Inc. will, at its discretion, either repair, replace, or issue credit for products that prove to be defective during the applicable warranty period.

For warranty service or repair, the product must be returned to Breathe Technologies, Inc. or a service facility designated by Breathe Technologies, Inc. with shipping prepaid by the end user.

Limitations of warranty; Exclusive remedy

Ordinary maintenance, as specified in this Instructions for Use and the Service Manual, is not covered under this Limited Warranty.

The Limited Warranty does not apply to damages or defects resulting from:

1. Improper or inadequate maintenance of the unit.
2. Failure to follow instructions, improper use or misuse of the unit.
3. Unauthorized modifications or repairs to the unit.
4. Use of the unit with unauthorized accessories, e.g., external battery or AC adapter.
5. Operation of the unit outside the specified environment.
6. Fire, flood, earthquake, acts of war or terrorism, or acts of God.

The foregoing limited warranty is in lieu of and specifically excludes and replaces, to the maximum extent permitted by applicable law, all other express or implied warranties, including, but not limited to, the implied warranties of merchantability and fitness for a particular purpose.

No person (including any agent, dealer, or representative of Breathe Technologies, Inc.) is authorized to make any representation or warranty concerning the product or its associated accessories, except to refer to this limited warranty.

The exclusive remedy with respect to any losses or damages resulting from any cause whatsoever shall be as specified above. Breathe Technologies, Inc. shall not be liable for any consequential or incidental damages of any kind, including, but not limited to, exemplary damages, special, punitive, commercial loss from any cause, business interruption of any nature, loss of profits or personal injury, even if Breathe Technologies, Inc. has been advised of the possibilities of such damages, however occasioned, whether by negligence or otherwise.

The maximum liability of Breathe Technologies, Inc. under this limited warranty shall in no event exceed the purchase price of the product.

Some states do not allow the exclusion or limitation of incidental or consequential damages, so the above limitations and exclusions may not apply to you. Some states do not allow limitations on how long an implied warranty lasts, so these limitations may not apply to you.

This limited warranty gives you specific legal rights, and you may also have other rights, which may vary from state to state.

The information contained in this document is of a proprietary and confidential nature and is intended only for the persons to whom it is directly transmitted by Breathe Technologies, Inc, a Hillrom Company. No part of this manual may be reproduced or transmitted in any form or by any means, electronic or mechanical, including photocopying and recording, for any purpose without the express written permission of Breathe Technologies, Inc.

Breathe, Breathe Technologies, CombO₂, Life2000, and Universal Circuit are trademarks of Breathe Technologies, Inc. For applicable US and Foreign Patent Coverage, see www.breathetechnologies.com. All other products or services mentioned in this manual are identified by the trademark or service marks of their respective companies or organizations. Breathe Technologies, Inc. disclaims any responsibility for specifying which marks are owned by which companies or organizations.



The Life2000® Ventilation System contains electrical components that must be disposed of according to the guidelines of the WEEE Directive (Waste in Electrical and Electronic Equipment) 2011/65/EU. Follow local regulations when disposing of the ventilator and accessories when disposal is required and at the end of the expected service life.

Life2000® Ventilation System Instructions for use

Copyright © 2024 by Breathe Technologies, Inc., a Hillrom Company

All rights reserved



Welch Allyn Inc.
4341 State Street Road
Skaneateles Falls, NY 13153 USA

Technical Support & Customer Service
800-426-4224

80030735 Ver. A

©2024. Breathe, Breathe Technologies, CombO₂, Life2000, and Universal Circuit are trademarks of Breathe Technologies, Inc., a Hillrom Company